



LAKES  
SHOWERING SPACES

# MODULAR WALK-IN

PERSONALISE YOUR SHOWERING SPACE

SPRING 2024



# LAKES LIFE EASIER

**Lakes Showering Spaces is one of the UK's longest established showering brands with a strong history and pedigree, having been founded almost 40 years ago. In that time Lakes has built up an award-winning reputation based on trust, quality and first-class customer service levels.**

At Lakes, we consider every element of the showering space, to make sure it suits the needs of the people using it. Whatever you want, whatever your style, scale or budget, our intelligent designs and market leading engineering mean there's a solution for you. The versatile new modular walk-in range provides more solutions than most, with 28 showering configurations and six finishes to choose from, so customising and personalising your showering space has never been easier, especially in the multi-generational world that we live in.

Designed in the UK for the UK market, this beautiful, elegant and minimalist range with its clean lines and frameless finish, is the epitome of the perfect showering sanctuary. Invigorating and relaxing, Lakes walk-ins provide the ultimate showering experience and an almost spa quality feeling, allowing you some much needed quality time for yourself.

## **CARBON NEUTRAL AND SUSTAINABLE**

Lakes has taken steps to be certified Carbon Neutral by changing how we operate as a business. Naturally, we recycle all our product, site and office waste. Our product packaging is 100% recyclable too, plus we're working with customers to take back our used packaging from installers through participating stockists. This step alone will remove 2,000 kilometres of plastic banding and two million pieces of polystyrene a year from landfill.

We continue to work with Carbon Footprint Ltd to offset the carbon emissions produced in the day-to-day running of our business by investing in environmental projects. For this work, Lakes is proud to have been awarded the Carbon Footprint Standard and recognised as a Carbon Neutral Plus organisation.

## **LIFETIME GUARANTEE**







Lakes' no-quibble Lifetime Guarantee covers all our showering spaces and spare parts and is also transferable. So even if you move home, the new owner will still be covered. And, if you have a problem with any part of your Lakes showering space, we will sort it out, quickly and efficiently. Our industry best customer service support means parts will probably arrive the next day. Another reason why we're always highly recommended by homeowners, stockists and installers across the UK.

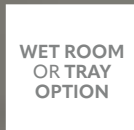

# CONTENTS

<b>PAGE 4-5</b>	LAKES TESTIMONIALS / ALLCLEAR GLASS
<b>PAGE 6-7</b>	WHY A FRAMELESS WALK-IN SHOWER / MODULAR WALK-IN FOR YOUR SHOWERING SPACE
<b>PAGE 8-9</b>	COLOUR FINISHES / BRACING BAR SOLUTIONS
<b>PAGE 10-11</b>	PROFILE, CORNER AND SEAL SOLUTIONS / DEFLECTOR SOLUTIONS
<b>PAGE 12-13</b>	LAKES WALK-IN SHOWER CONFIGURATIONS TO CREATE YOUR PERSONAL SHOWERING SPACE
<b>PAGE 14-15</b>	A GUIDE TO PERSONALISING YOUR SHOWER SPACE
<b>PAGE 16-19</b>	<b>FLAT WALL THREE-SIDED WET ROOMS</b> WITHOUT DEFLECTOR PANELS
<b>PAGE 20-23</b>	<b>FLAT WALL THREE-SIDED WET ROOMS</b> WITH DEFLECTOR PANELS
<b>PAGE 24-27</b>	<b>CORNER WET ROOMS</b> WITHOUT DEFLECTOR PANELS
<b>PAGE 28-33</b>	<b>CORNER WET ROOMS</b> WITH DEFLECTOR PANELS
<b>PAGE 34-37</b>	<b>WET ROOM PANEL</b> WITHOUT DEFLECTOR PANELS
<b>PAGE 38-41</b>	<b>WET ROOM PANEL</b> WITH DEFLECTOR PANELS
<b>PAGE 42-47</b>	<b>WALK THROUGH WET ROOMS</b> WITH AND WITHOUT DEFLECTOR PANELS
<b>PAGE 48-49</b>	AMBIENT WET ROOM
<b>PAGE 50-51</b>	HORIZON WET ROOM
<b>PAGE 52-54</b>	PLAN YOUR OWN PERSONAL SHOWERING SPACE
<b>PAGE 55</b>	PRODUCT DETAILS

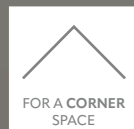
## PRODUCT FEATURES

 <p><b>WET ROOM OR TRAY OPTION</b></p>	 <p><b>LIFETIME GUARANTEE</b></p>	 <p><b>8mm</b></p>	 <p><b>10mm</b></p>
Wet room or tray option	Lifetime guarantee	8mm toughened safety glass	10mm toughened safety glass
 <p><b>FOR A STRAIGHT, OPEN SPACE</b></p>	 <p><b>FOR A CORNER SPACE</b></p>	 <p><b>FOR AN ALCOVE SPACE</b></p>	
Flat wall	Corner	Recess	

# LAKES TESTIMONIALS

"Keep doing what you always have done. Nobody can ask any more of a supplier. Thanks for 14 years of great service".

**DEB & RALPH CROOK, RJC**

"You deserve recognition and praise for the service I received from you today. You answered the phone very promptly and managed to quickly find the shower door for which I needed a spare part. The two gentlemen I spoke to on separate calls could not have been more pleasant and helpful. If only more companies could behave in a similar fashion".

**N KELLY**

"Superb quality, excellent after sales and great prices. Thank you".

**DIANE ROBERTS**

"What a pleasure to be able to call a company and get through straight away. I purchased an ex-demo shower enclosure from a local shop. Unfortunately, lots of seals were missing and so were the instructions. After five extremely helpful minutes on the phone, I knew what I needed to do and the parts were sent in the post to me, free of charge. Thank you".

**GARY WILTON**

"The Lakes warranty is outstanding as is their customer service".

**VICTORIA KLYVE**

"I have found AllClear® brilliant. I live in an area where the water is particularly hard and AllClear® keeps my shower screen sparkling clean. The water seems to bounce off the glass, leaving no need for constant cleaning. I would definitely recommend this product".

**FIONA CLISSOLD, TRUSTPILOT**

"The service has been second to none, going that extra mile to find a resolution and help with a replacement part for my shower. I would recommend Lakes to anyone, especially with your excellent after sales service. Thank you".

**JOHN S INNES**

"My experience of aftercare/customer service could only be described as 5-star. Having purchased shower doors and having managed to damage a part during fitting, I turned to Lakes hoping that a replacement was available and seeking to purchase the part needed. The response was instant. The email simply said part on its way and it was free. Nearly fell off my seat. Arrived 2 days later. Made my day to be honest".

**KELLY WILSON, N. IRELAND**

"Lakes spares department was outstanding. Craig was especially helpful and the quality of the shower enclosure must be the best on the market".

**DAVID STARKEY**



# LAKES GLASS FOR A SUPERIOR SHOWERING EXPERIENCE

**The Lakes Modular Walk-in range conforms to the most exacting and required UK and European safety and quality standards for ultimate peace of mind.**

With a choice of luxury 8mm or deluxe 10mm glass, all panels are 2 metres high as standard and made from toughened safety glass, conforming to BS EN 14428:2015+A1:2018 and carries the UKCA marking. The toughened glass conforms to BS EN12150-1 accreditation (which is etched onto each piece of glass).

This ensures that every Lakes' walk-in shower configuration is:

- Impact resistant and safe in the event of breakage
- Durable and resistant to corrosion - all Lakes components pass salt spray tests (level 10)
- Resistant to chemicals, staining and everyday cleaning products
- Resistant to humidity and heat - no cracking or discolouration
- Ultra durable - all parts are tested to 20,000 opening/closing cycles
- Strong, stable and watertight
- Lakes also regularly test products above and beyond mandatory standards, allowing us to offer a Lifetime guarantee.

Lakes Modular Walk-ins feature a wide choice of clear panel sizes to suit all room sizes, layouts, budgets and user needs. The main front panel ranges in size from an opulent 1400mm wide to sizes more suited for smaller showering areas or when a hinged deflector panel is used.

There's also an end/side panel to suit every shower tray size, providing water retention and protecting other bathroom products fitted within the shower area.

05

**AllClear**<sup>®</sup>  
from Lakes

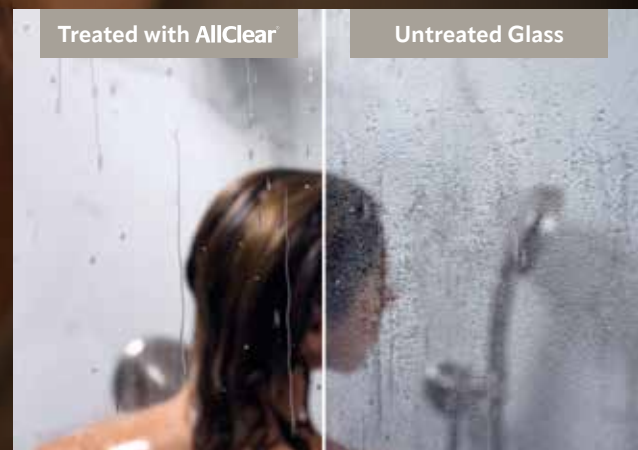



# WHY A FRAMELESS WALK-IN SHOWER?

## What is the appeal of upgrading to or specifying a frameless glass walk-in shower enclosure?

### STREAMLINED STYLE

Frameless walk-in shower glass brings a touch of refinement to any bathroom, instantly improving its aesthetic appeal. The clean lines and virtually seamless design create a look that's timeless, contemporary, deluxe, and comfortable.

### SPACIOUS

Say goodbye to the restriction of traditional shower doors and curtains. Frameless walk-in showers introduce a sense of openness, making a bathroom appear larger and airier. It's amazing how a simple change can redefine the entire space, even in a tighter corner.

### PERSONALISATION

Whether a bathroom style is modern, classic, or contemporary, a frameless glass shower enclosure will complement most designs and decors. The simplicity of the glass allows for easy mixing with different room colour schemes, taps and showering hardware.

### EASY MAINTENANCE

Cleaning becomes so simple with frameless glass. No more nooks and crannies where mould, mildew or grime hides and builds up. A quick daily wipe down, and your shower area will shine like new.

### DURABLE

Engineered in the UK to be long-lasting, our frameless glass enclosures are built to last. The absence of large frames reduces the risk of visual deterioration caused by limescale, cleaning products and general wear and tear, ensuring your walk-in enclosure stands the test of time. This is backed up by the Lakes Lifetime Guarantee.

### NATURAL LIGHT IMPACT

The frameless design allows more natural light into the open showering area, contributing to a brighter and more welcoming bathroom environment.

### SPA-LIKE EXPERIENCE

Our frameless walk-ins will transform your daily shower into a spa-like retreat. The clear nature of the glass enclosure enhances the overall feel, creating a calm and relaxing atmosphere.

### FUTURE PROOF

Frameless glass walk-in shower enclosures can be considered an investment for the future and can even influence the sale of your home, especially if showering access and stability is potentially challenging for new owners. Property buyers often appreciate modern and stylish features that require minimal maintenance.

### SUSTAINABLE

Frameless walk-ins use less metal, less packaging and requires less cleaning. And, with far fewer moving parts, frameless walk-ins suffer less from wear and tear and the need for spare parts. All parts within our frameless walk-ins are fully recyclable.

# MODULAR WALK-IN FOR YOUR SHOWERING SPACE



//RECESS/ALCOVE

**Our modular walk-in systems can either be installed onto a shower tray or flush fit directly to a tiled wet room floor, providing great accessibility for the specific needs of individuals of all ages and challenges.**

Lakes modular wet rooms are one of very few ranges that are compatible with almost any bathroom layout, size and user needs, combining safety, style and versatility in bathroom design and creating that spa look and feel. Suitable for recess, corner and flat-wall installations and where space in the bathroom is limited.

#### **RECESS/ALCOVE – SEE PAGES 35-47**

Ideal for smaller bathrooms, ensuite, guest rooms or loft conversions, but more often installed in the space where a bath is being removed and replaced with a shower.

Using one main fixed front panel on a floor substrate allows homeowners the flexibility to design a personalised and contemporary showering space and choose from one of six colour finishes. For added luxury [and keep the water within the showering area], add a fixed or hinged deflector panel.



//CORNER

#### **CORNER – SEE PAGES 25-47**

A corner space is often the most common area available and can offer more options in terms of form and function.

With more floor space often available, two panels [main/front with a return/side or return panel] can be used. This allows the walk-in layout to work more like a standard corner shower enclosure.

The side panel is a practical solution to simply preventing water splashing outside the showering area. Corner walk-in set-ups offer as much splash protection as a normal moving shower door. What's more, the 90° glass-to-glass join feature can be made to look minimal using a corner bracket and clear sealant or using a more traditional full height corner post.

#### **FLAT WALL (3 -SIDED) – SEE PAGES 16-23**

Not always reserved for larger bathrooms, but again it could be a space created as a result of a bath being replaced with a showering area. Unlike standard moving doors, creating a 3-sided enclosure with a modular walk-in set up is much easier than trying to design and install a customary enclosure with a sliding, bifold or hinged door. It's also much more cost effective.

Alternatively, a flat wall walk-in shower can also be configured as a 'walk-through' shower with double entry points, featuring a single fixed glass panel.

In summary, there's a Lakes walk-in shower set up to suit any size or shape of bathroom, and any budget .



//FLAT WALL





The shower fittings appearing in this brochure are produced by **JTP**, a long established tapware brand carefully designed in the UK for the UK market. Please visit [www.jtpuk.com](http://www.jtpuk.com)

# COLOUR FINISHES

08

**To provide the ultimate in bathroom personalisation Lakes has carefully developed a collection of beautiful colour finishes for all metallic parts to suit individual tastes and complement any bathroom design scheme, providing the perfect accompaniment to today's showering and brassware fittings, as follows:**

## MONOCHROME

Choose from either our timeless Silver which offers a near mirror quality finish or make a statement with our distinctive and bold Matt Black. Either colour will complement most wall tile colours and designs.

## URBAN NEUTRAL

If you're looking for something a little softer than dramatic black, Lakes' Gun Metal will add calm sophistication to your bathroom – the perfect colour to complement woods, concrete and other metallic finishes.

Brushed Nickel will grace any modern or classically styled bathroom design scheme, and a wonderful alternative to traditional chrome colours. The silky texture and colour tones are an ideal companion for marbles, terracotta, concrete, and mid-tone woods.

## NATURAL/WARM

Create a soothing bathroom sanctuary with a hint of luxury. Brushed Brass - a gentle hint of gold combined with delicate brushing, makes a genuine and soothing bathroom design statement. For those looking for a hint of finesse, our Brushed Bronze will elevate any bathroom scheme. Both finishes are perfect when paired with paler woods and stones.

## MIXAGE

The modular format of our walk-in system allows true bathroom personalisation. Why not combine Black with Brushed Brass or Brushed Nickel, for instance?

## ALUMINIUM WALL PROFILES AND BRACING BARS

- Anodised aluminium
- No rust or corrosion
- Easy to clean
- Super strong, yet lightweight for ease of installation
- Scratch and chip resistant anodised finish
- Super resilient to humidity in the bathroom, day to day wear and tear and cleaning products
- Conforms and exceeds EN 12373-1
- Brushed or smooth polished finish depending on colour choice
- Colour finish lasts a lifetime – no fading or discolouration
- Sustainable - each component part can be 100% recycled

## HARDWARE – HINGES, GLASS CLAMPS, WALL BRACKETS

- Precision die cast from zinc alloy
- PVD (Physical Vapour Deposition) finished
- Outstanding durability
- High corrosion resistance
- Improved aesthetic appearance
- Very high wear resistance
- Environmentally friendly (no harmful chemicals used)
- All PVD parts are 100% recyclable



# BRACING BAR SOLUTIONS



Whether your bathroom demands 1, 2 or 3 walk-in screens and a deflector panel, our elegant bracing bars will provide the perfect blend of form and function. Each option is superbly engineered for durability and strength with screw points discreetly concealed from view, on the wall or ceiling.

## MINIMAL DESIGN WALL BRACING BAR BB1

- Safe and strong
- Supplied 1200mm length for cutting to length on install
- Complete with glass clamp, wall bracket and T- joint
- Default bracing bar for full height deflector hinge BY8/BY10
- Not suitable for PHG/10 hinge or fixed deflector panels



//BRACING BAR BB1



//BRACING BAR BB2

## GLASS TO WALL BRACING & HINGED DEFLECTOR APPLICATIONS BB2

- Safe and strong
- Supplied 1200mm length for cutting to length on install
- Complete with glass clamp, wall bracket and T- joint

## INLINE BRACING FOR FIXED DEFLECTOR PANEL TO WALL BB3

- Safe and strong
- Provided at 1200mm long for cutting to length on install
- Supplied with glass clamp, wall bracket and T- joint
- Required when using a fixed 90° non-rotating deflector panel
- Not suitable for walk through glass layouts



//BRACING BAR BB3



//ANGLED BRACING BAR

## ANGLED BRACING BAR AB

- An understated option for use when an overhead bar is not desired or not possible
- Suitable for fixed panels up to 1000mm wide
- No assembly required, ready to use with glass clamp and wall bracket ends
- Nominally 45° x 500mm long. If space demands, it can be used between 30° & 60°

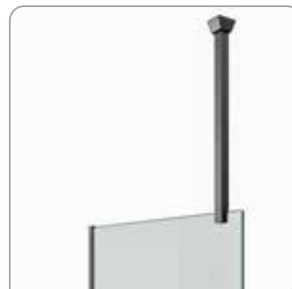

//GLASS TO CEILING BRACING BAR



//FLOOR TO CEILING BRACING BAR F2C

## GLASS TO CEILING BRACING BAR G2C

- A subtle yet incredibly secure glass stabilising option
- Complete with glass clamp and decorative cover
- Supplied at 600mm long, for cutting to length
- Recommended for use on panels up to 1000mm only

## FLOOR TO CEILING BRACING BAR F2C

- A stunning and safe method to secure fixed panels
- Requires ceiling bracket and decorative cover
- Supplied at 2600mm long, for cutting to length

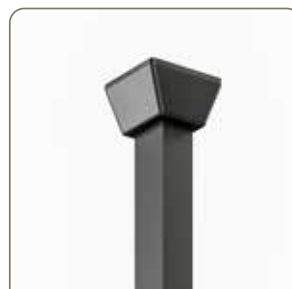

//CEILING BRACKET 2CB

## CEILING BRACKET 2CB

For use with 'to Ceiling' type bracing bars (G2C or F2C)

*Note: We recommend that all main panels over 500mm wide are installed with your choice of bracing bar.*



//WALL PROFILE



//CORNER BRACKET



//CORNER POST

# PROFILE, CORNER AND SEAL SOLUTIONS

**Our wall and corner profile solutions offer maximum versatility and stability and feature concealed fixings plus plenty of adjustability for those out of square walls.**

## **WALL PROFILE**

**1x wall profile is required whenever a glass panel connects to a wall.**

- Slim, discreet design supplied with push in seals for 8mm and 10mm glass
- Profile top cover cap
- 20mm out of plumb adjustment for any wall surface tiles or wall panels

## **CORNER BRACKET CNR8 / CNR10**

- A minimalist designer option to join two 8 or 10mm glass panels securely at 90°
- Brackets feature concealed fixing
- A transparent corner seal provides a safe and secure corner connection

## **CORNER POST**

**Glass to glass CP8 / CP10.**

- A feature option to join two 8 or 10mm glass panels securely at 90°
- Decorative top cap to complement wall profiles and bracing bars

# DEFLECTOR SOLUTIONS

To enrich your walk-in shower design and provide water overspray protection, choose from one of our sumptuous deflector panels options. Truly personalise your showering space by selecting from our friction-free rotating panels to provide easy walk-in access or opting for the ultimate spa/hotel style fixed deflector panel with clear seals. Rotating panels can also be retrofitted.

## FULL HEIGHT ROTATING DEFLECTOR HINGE AND PANEL BY8 / BY10

- Sleek and elegant
- Smooth friction-free 180° inward and 90° outward rotation
- Complete with 300mm wide glass panel in 8 or 10mm glass
- Use with BB1 bracing bar
- Maximum protection from water overspray

## HINGE TYPE DEFLECTOR PANEL PHL / PHR + PHG

- Sleek minimalist on-glass hinge
- Superb finish, luxury fee, heavy duty and perfect performance
- 180° inward only rotation and concealed fittings
- Available left and right handed
- Available with 300mm deflector panel with seal in 8mm (PHG8) and 10mm (PHG10)
- Use with BB2 bracing bar

## FIXED 90° DEFLECTOR PANEL G8 / G10 + CNR / CP

- A simple yet practical 90° fixed glass deflector
- 200mm wide panel, 8 and 10mm glass
- Can be fixed to the main panel using our corner post or corner bracket with ultra clear seal
- Use with BB3 glass to wall bracing bar
- An optional foot kit is available for installations where deflector glass is unsupported at base



**Note:** All Hinged Deflector Panels are handed please suffix codes with L or R. All illustrations show left hand option.



//FULL HEIGHT ROTATING DEFLECTOR HINGE  
AND PANEL BY8 / BY10



//HINGE TYPE DEFLECTOR PANEL  
PHL / PHR + PHG



//FIXED 90° DEFLECTOR PANEL  
G8 / G10 + CNR / CP

# LAKES WALK-IN SHOWER CONFIGURATIONS TO CREATE YOUR PERSONAL SHOWERING SPACE

**Infinite versatility. Design the walk-in layout that's perfect for your individual home, desired showering space, style, and dreams, from a wide range of 8mm and 10mm glass panel and hardware options.**

Whether for recess, corner and flat wall all products are available in our six colour finishes.

The examples shown represent almost every configuration possible, but If you're considering something different to these, please consult your retailer for advice.

## //HINTS AND TIPS



**Lakes' walk-in panels can be fitted to tiled floors and most standard shower trays.** However, if you are installing onto a shower tray, we recommend using a Lakes shower tray or alternatively, consult your retailer for more information.

**When choosing your main panel sizes we recommend allowing entry/exit access of 500mm minimum.** When ordering your glass sizes always take measurements after wall tiles or wall panels have been installed.

 Indicates rotating deflector panel

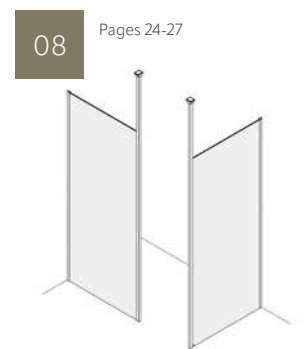
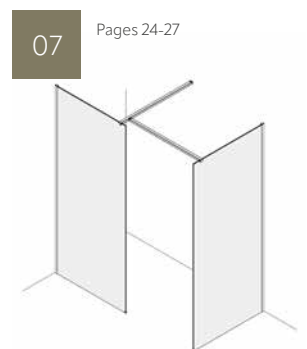
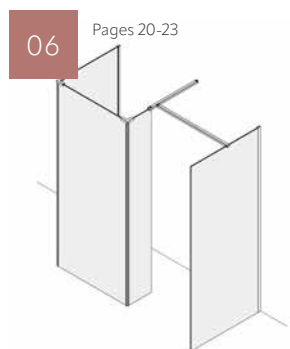
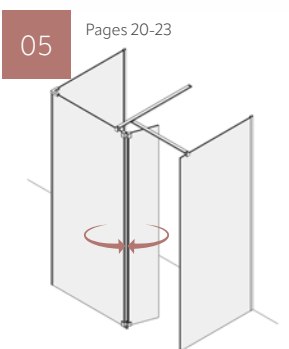
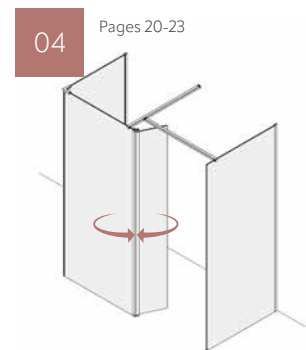
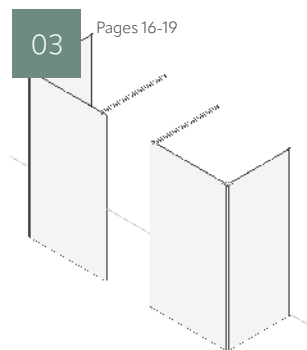
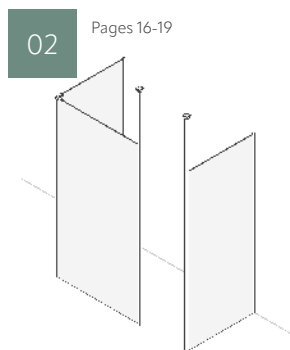
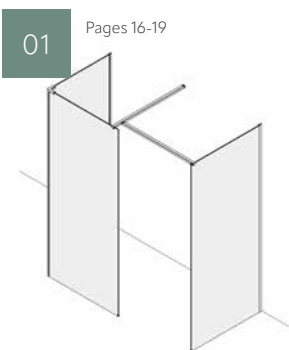

09 Pages 24-27

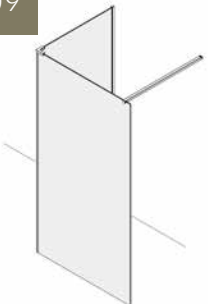

10 Pages 24-27

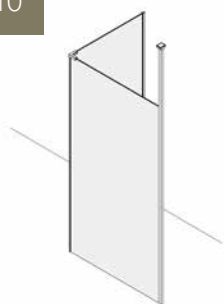

11 Pages 28-33

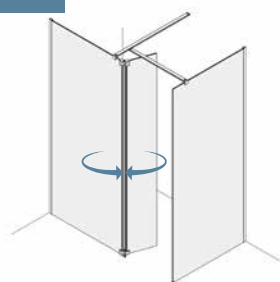

12 Pages 28-33

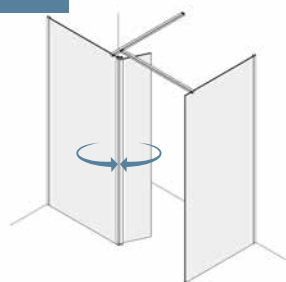

13 Pages 28-33

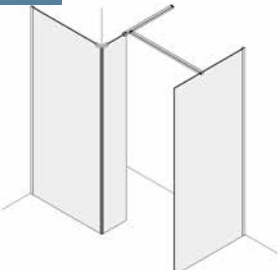

14 Pages 28-33

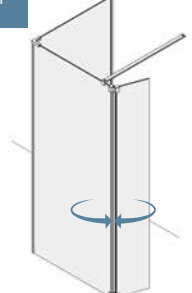

15 Pages 28-33

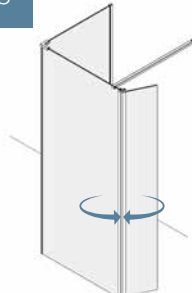

16 Pages 28-33

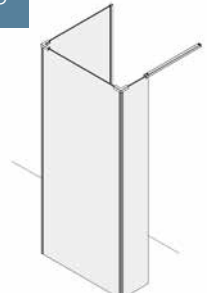

17 Pages 34-37

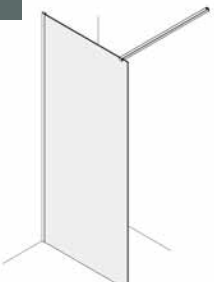

18 Pages 34-37

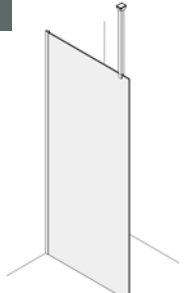

19 Pages 34-37

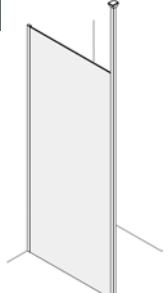

20 Pages 34-37

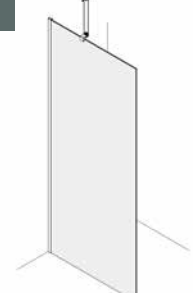

21 Pages 38-41

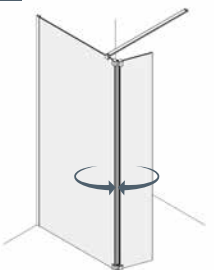

22 Pages 38-41

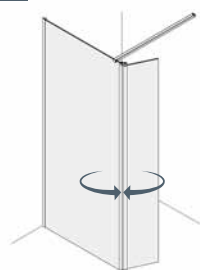

23 Pages 38-41

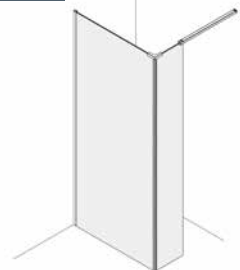

24 Pages 42-47

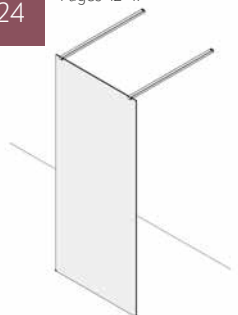

25 Pages 42-47

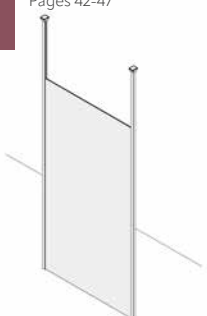

26 Pages 42-47

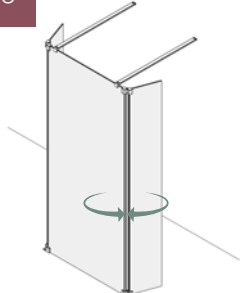

27 Pages 42-47

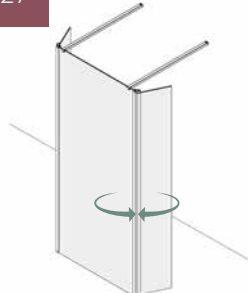

28 Pages 42-47

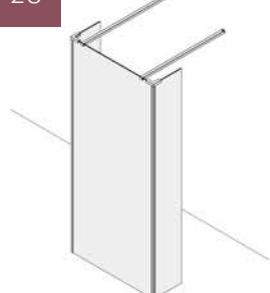

# A GUIDE TO PERSONALISING YOUR SHOWER SPACE

1

Select your showering space  
(recess, corner or flat wall).

2

Measure the floor space (width  
x depth) to include all wall tiles  
or wall coverings.

3

Choose your glass panels  
(8mm or 10mm) and glass  
size(s), plus a wall profile for  
each larger glass panel.

4

Select your bracing/stabilising  
preference to suit the number of  
glass panels, room construction  
and optional deflector panels.

5

Choose your glass connecting  
and deflector options.

6

Choose your colour finish.

7

Enjoy!

Creating your own personalised walk-in showering space could not be easier with a choice of six colour finishes to complement your bathroom décor.

14

## //HINTS AND TIPS



- We advise taking the measurements at least twice to check they're correct.
- When measuring the space ensure the dimension includes final wall covering/tiles
- We recommend allowing a minimum 500mm access gap between panels.
- If you're choosing a full height hinged deflector panel, make sure you have enough space outside and inside of the showering space to open and close the panel.
- If the glass is installed on a shower tray, ensure the tray has a minimum flat ledge of 40mm.
- When measuring, it's not unusual to find some walls are not 100% straight for their entire height. Lakes wall profiles offer up to 20mm adjustment.
- If you're replacing an existing shower enclosure and shower tray, check there haven't been any water leaks and that the intended floor area or tray is sound.
- Check the position and height of the shower valve, shower head etc to ensure all users can comfortably access the controls and shower head.

# KEY COMPONENT PARTS

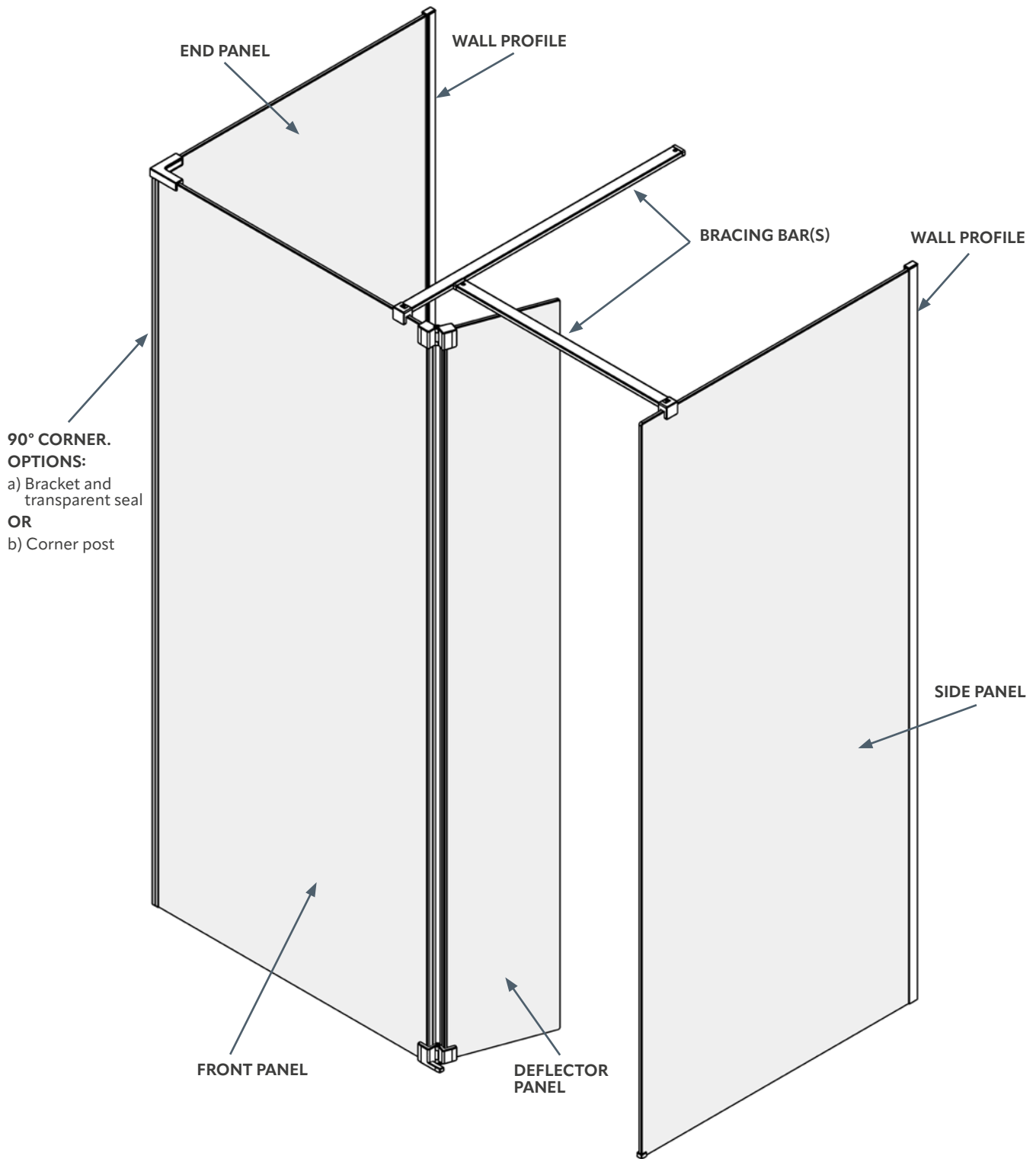

# FLAT WALL THREE-SIDED WETROOM DESIGN WITHOUT DEFLECTOR PANELS

16

A luxurious option for a walk-in shower space and you don't necessarily need a big bathroom to start with. Unlike standard enclosures with moving doors such as a slider or hinged door, creating a 3-sided enclosure with a modular walk-in set up is much easier to install – and it can be more cost effective!

The 90° glass-to-glass feature can be joined by a corner bracket and clear seal, or a by the more traditional full height corner post.

Choose from our wide selection of bracing bars, all available in six stunning finishes.

All our glass features AllClear® as standard, for ease of cleaning.

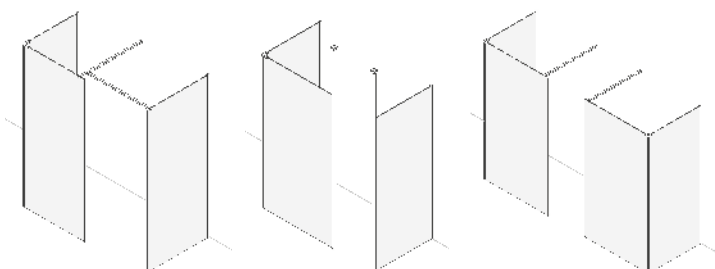





WET ROOM  
OR TRAY  
OPTION

  
LIFETIME  
GUARANTEE

  
FOR A STRAIGHT,  
OPEN SPACE

8mm

10mm

# FLAT WALL THREE-SIDED WETROOM DESIGN WITHOUT DEFLECTOR PANELS

01

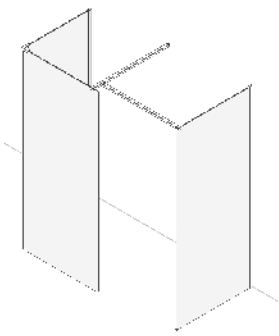

02

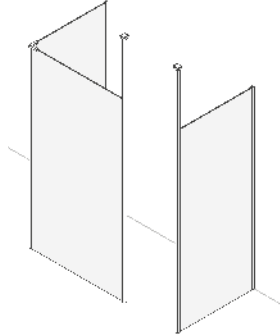

03

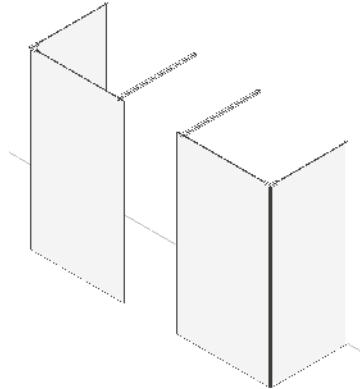

## 8mm

- 3 x Glass G8- ▶
- 2 x Wall Profile WPS ✓
- 2 x Bracing Bar BB1 ✓
- Corner Bracket CNR8 ✓
- Corner Seal CNR8SEAL

## 8mm

- 3 x Glass G8- ▶
- 2 x Wall Profile WPS ✓
- 2 x Bracing Bar F2C8 ✓
- 2 x Ceiling Bracket 2CB ✓
- Corner Bracket CNR8 ✓
- Corner Seal CNR8SEAL

## 8mm

- 4 x Glass G8- ▶
- 2 x Wall Profile WPS ✓
- 2 x Bracing Bar BB1 ✓
- 2 x Corner Bracket CNR8 ✓
- 2 x Corner Seal CNR8SEAL

## 10mm

- 3 x Glass G10- ▶
- 2 x Wall Profile WPS ✓
- 2 x Bracing Bar BB1 ✓
- Corner Bracket CNR10 ✓
- Corner Seal CNR10SEAL

## 10mm

- 4 x Glass G10- ▶
- 2 x Wall Profile WPS ✓
- 2 x Bracing Bar BB1 ✓
- 2 x Corner Bracket CNR10 ✓
- 2 x Corner Seal CNR10SEAL

KEY: ✓ add colour to code ▶ add size to code





### GLASS PANELS

WIDTH (mm)*	HEIGHT (mm)	8mm GLASS	PRICE	10mm GLASS	PRICE
200	1981	G8-020	£105.13	G10-020	£117.75
300	1981	G8-030	£128.21	G10-030	£143.59
400	1981	G8-040	£150.28	G10-040	£168.31
500	1981	G8-050	£175.33	G10-050	£205.82
600	1981	G8-060	£200.07	G10-060	£236.18
700**	1981	G8-070	£213.90	G10-070	£253.61
800**	1981	G8-080	£236.40	G10-080	£284.69
900**	1981	G8-090	£259.37	G10-090	£310.13
1000**	1981	G8-100	£282.48	G10-100	£338.89
1100**	1981	G8-110	£304.91	G10-110	£366.87
1200**	1981	G8-120	£327.42	G10-120	£394.92
1400**	1981	G8-140	£382.52	N/A	N/A

\*Sizes shown are nominal.  
 \*\*Widths indicated are undersized by 48mm to allow for tiling, wall profile (adjustment) and to ensure fit within shower base width.

### WALL PROFILE (UNIVERSAL 8mm AND 10mm GLASS)

DESCRIPTION	HEIGHT (mm)	CODE	SILVER	BLACK	BRUSHED BRASS	BRUSHED NICKEL	BRUSHED BRONZE	GUN METAL
*Add colour suffix to code e.g. WPSB = Black			S	B	BRS	N	BRZ	GUN
20mm Wall Profile with seals	2000	WPS*	£65.02		£71.52			

### 90° CORNER JOINING OPTIONS

DESCRIPTION	HEIGHT (mm)	CODE	SILVER	BLACK	BRUSHED BRASS	BRUSHED NICKEL	BRUSHED BRONZE	GUN METAL
*Add colour suffix to code e.g. CNR8B = Black			S	B	BRS	N	BRZ	GUN
<b>MINIMAL DESIGN</b>								
Corner Bracket 8mm		CNR8*	£35.65		£43.76			
Transparent Corner Seal 8mm	2000	CNR8SEAL	£19.03		£19.03			
Corner Bracket 10mm		CNR10*	£55.23		£64.50			
Transparent Corner Seal 10mm	2000	CNR10SEAL	£19.18		£19.18			
<b>CORNER POST STYLE</b>								
Corner Post 8mm	2000	CP8*	£60.41		£66.69			
Corner Post 10mm	2000	CP10*	£64.10		£70.69			

### BRACING BAR AND OPTIONS

DESCRIPTION	LENGTH (mm)	CODE	SILVER	BLACK	BRUSHED BRASS	BRUSHED NICKEL	BRUSHED BRONZE	GUN METAL
*Add colour suffix to code e.g. BB1B = Black			S	B	BRS	N	BRZ	GUN
<b>DEFAULT</b>								
Front to back Bracing Bar (includes T joiner)	1200	BB1*	£50.56		£58.88			
<b>OPTIONS</b>								
Glass to Ceiling Brace	600	G2C*	£55.45		£68.95			
Floor to Ceiling Post 8mm	2600	F2C8*	£95.15		£110.38			
Ceiling Bracket		2CB*	£21.78		£30.79			



//BRACING BAR OPTIONS



//FULL HEIGHT CORNER POST

//MINIMAL CORNER BRACKET

All Prices are inclusive of VAT.

//05 THREE SIDED WALK-IN WITH  
DEFLECTOR IN GUN METAL



20

WET ROOM  
OR TRAY  
OPTION

  
**LIFETIME  
GUARANTEE**

—  
FOR A STRAIGHT,  
OPEN SPACE



# FLAT WALL THREE-SIDED WETROOM DESIGN WITH DEFLECTOR PANELS

Match a 3-sided wet room design with any one of Lakes' fixed or rotating deflector panel options, to prevent water 'splash out'.

Our truly elegant, full height deflector panels 180° inward and 90° outward rotation. More minimal design 180° inward folding or the hotel look fixed panel.

Once you've chosen your preferred deflector panel, select the bracing bar and finish of your choice to create your perfect personalised showering space.

All rotating deflector panels can be retro fitted.



//06 THREE SIDED WALK-IN WITH FIXED DEFLECTOR IN MATT BLACK



//04 THREE SIDED WALK-IN WITH FULL HEIGHT DEFLECTOR IN SILVER

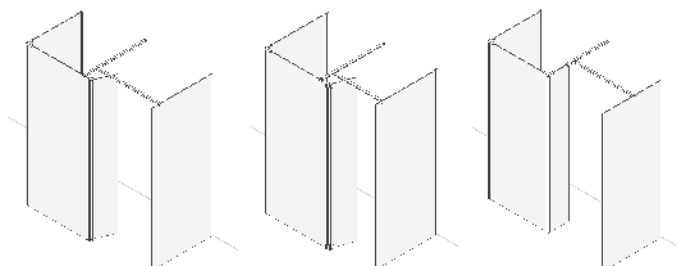

FLAT WALL THREE SIDED  
WETROOM DESIGN  
WITH DEFLECTOR  
PANELS

# FLAT WALL THREE-SIDED WETROOM DESIGN WITH DEFLECTOR PANELS

04

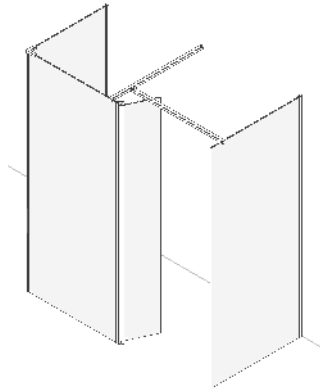

05

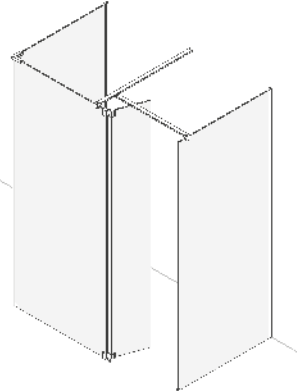

06

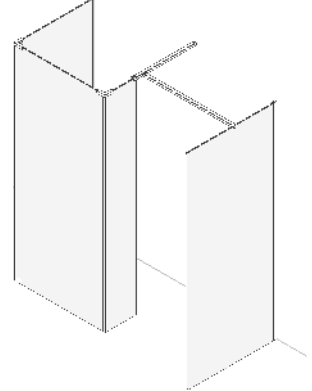

Left hand hinge shown

**8mm**

- 3 x Glass G8- ▶
- 2 x Wall Profile WPS ✓
- 2 x Bracing Bar BB1 ✓
- Corner Bracket CNR8 ✓
- Corner Seal CNR8SEAL
- Profile Deflector BY8-3 ✓

**8mm**

- 3 x Glass G8- ▶
- 2 x Wall Profile WPS ✓
- 2 x Bracing Bar BB2 ✓
- Corner Bracket CNR8 ✓
- Corner Seal CNR8SEAL
- Hinge Kit PH<sup>X</sup> ✓
- Glass & Seal PHG8-030

**8mm**

- 4 x Glass G8- ▶
- 2 x Wall Profile WPS ✓
- 2 x Corner Bracket CNR8 ✓
- 2 x Corner Seal CNR8SEAL
- Bracing Bar BB3 ✓
- Bracing Bar BB1 ✓

**10mm**

- 3 x Glass G10- ▶
- 2 x Wall Profile WPS ✓
- 2 x Bracing Bar BB1 ✓
- Corner Bracket CNR10 ✓
- Corner Seal CNR10SEAL
- Profile Deflector BY10-3 ✓

**10mm**

- 3 x Glass G10- ▶
- 2 x Wall Profile WPS ✓
- 2 x Bracing Bar BB2 ✓
- Corner Bracket CNR10 ✓
- Corner Seal CNR10SEAL
- Hinge Kit PH<sup>X</sup> ✓
- Glass & Seal PHG10-030

**10mm**

- 4 x Glass G10- ▶
- 2 x Wall Profile WPS ✓
- 2 x Corner Bracket CNR10 ✓
- 2 x Corner Seal CNR10SEAL
- Bracing Bar BB3 ✓
- Bracing Bar BB1 ✓

**KEY:** ✓ add colour to code ▶ add size to code ✕ add L or R to code for left or right handed option

## GLASS PANELS

WIDTH (mm)*	HEIGHT (mm)	8mm GLASS	PRICE	10mm GLASS	PRICE
200	1981	G8-020	£105.13	G10-020	£117.75
300	1981	G8-030	£128.21	G10-030	£143.59
400	1981	G8-040	£150.28	G10-040	£168.31
500	1981	G8-050	£175.33	G10-050	£205.82
600	1981	G8-060	£200.07	G10-060	£236.18
700**	1981	G8-070	£213.90	G10-070	£253.61
800**	1981	G8-080	£236.40	G10-080	£284.69
900**	1981	G8-090	£259.37	G10-090	£310.13
1000**	1981	G8-100	£282.48	G10-100	£338.89
1100**	1981	G8-110	£304.91	G10-110	£366.87
1200**	1981	G8-120	£327.42	G10-120	£394.92
1400**	1981	G8-140	£382.52	N/A	N/A

\*Sizes shown are nominal.  
\*\*Widths indicated are undersized by 48mm to allow for tiling, wall profile (adjustment) and to ensure fit within shower base width.

## WALL PROFILE (UNIVERSAL 8mm AND 10mm GLASS)

DESCRIPTION	HEIGHT (mm)	CODE	SILVER	BLACK	BRUSHED BRASS	BRUSHED NICKEL	BRUSHED BRONZE	GUN METAL
*Add colour suffix to code e.g. WPSB = Black			S	B	BRS	N	BRZ	GUN
20mm Wall Profile with seals	2000	WPS*		£65.02			£71.52	

## 90° CORNER JOINING OPTIONS (INCLUDING FIXED DEFLECTOR)

DESCRIPTION	HEIGHT (mm)	CODE	SILVER	BLACK	BRUSHED BRASS	BRUSHED NICKEL	BRUSHED BRONZE	GUN METAL
*Add colour suffix to code e.g. CNR8B = Black			S	B	BRS	N	BRZ	GUN
<b>MINIMAL DESIGN</b>								
Corner Bracket 8mm		CNR8*		£35.65			£43.76	
Transparent Corner Seal 8mm	2000	CNR8SEAL		£19.03			£19.03	
Corner Bracket 10mm		CNR10*		£55.23			£64.50	
Transparent Corner Seal 10mm	2000	CNR10SEAL		£19.18			£19.18	
<b>CORNER POST STYLE</b>								
Corner Post 8mm	2000	CP8*		£60.41			£66.69	
Corner Post 10mm	2000	CP10*		£64.10			£70.69	
<b>FIXED DEFLECTOR BRACING</b>								
Inline Bracing Bar	1200	BB3*		£49.63			£59.64	

## 180° MINIMAL STYLE 300mm HINGE DEFLECTOR (8mm AND 10mm GLASS)

DESCRIPTION	HEIGHT (mm)	CODE	SILVER	BLACK	BRUSHED BRASS	BRUSHED NICKEL	BRUSHED BRONZE	GUN METAL
*Add colour suffix to code e.g. PHLB = Black			S	B	BRS	N	BRZ	GUN
<b>MINIMAL STYLE</b>								
Hinge Set LH (as shown)		PHL*		£115.86			£132.28	
Hinge Set RH (opposite shown)		PHR*		£115.86			£132.28	
Deflector Glass and Transparent Seal 8mm	2000	PHG8-030		£128.21			£128.21	
Deflector Glass and Transparent Seal 10mm	2000	PHG10-030		£140.49			£140.49	
<b>BRACING DEFAULT</b>								
Front to back Bracing Bar (for minimalist hinge - includes T joiner)	1200	BB2*		£54.56			£60.37	

## 270° FULL HEIGHT 300mm HINGE DEFLECTOR (8mm AND 10mm GLASS)

DESCRIPTION	HEIGHT (mm)	CODE	SILVER	BLACK	BRUSHED BRASS	BRUSHED NICKEL	BRUSHED BRONZE	GUN METAL
*Add colour suffix to code e.g. BY8B = Black			S	B	BRS	N	BRZ	GUN
Full Height Hinge Deflector Assembly 8mm	2000	BY8*		£239.15			£263.06	
Full Height Hinge Deflector Assembly 10mm	2000	BY10*		£249.83			£274.82	
<b>BRACING DEFAULT</b>								
Front to back Bracing Bar (includes T joiner)	1200	BB1*		£50.56			£58.88	

## BRACING OPTIONS

DESCRIPTION	LENGTH (mm)	CODE	SILVER	BLACK	BRUSHED BRASS	BRUSHED NICKEL	BRUSHED BRONZE	GUN METAL
*Add colour suffix to code e.g. G2CB = Black			S	B	BRS	N	BRZ	GUN
Glass to Ceiling Brace	600	G2C*		£55.45			£68.95	
Floor to Ceiling Post 8mm	2600	F2C8*		£95.15			£110.38	
Ceiling Bracket		2CB*		£21.78			£30.79	
Optional Foot Kit (for Fixed Deflector)	2000	FTK*		£22.18			£31.96	

Foot Kit recommended when fixed deflector glass is over tray recess

All Prices are inclusive of VAT.

# CORNER WETROOM DESIGN WITHOUT DEFLECTOR PANELS



//09 CORNER WALK-IN WITH  
CORNER BRACKET IN  
MATT BLACK

24

The corner of a bathroom is usually the ideal location to showcase a walk-in showering space. Our extensive collection of panel sizes offers a solution for almost every bathroom. Lakes' corner options are designed to offer maximum flexibility, practicality, and style.

The side panel will help reduce water splash-out and protect other bathroom accessories, furniture from overspray. Simply add the beautiful bracing bar finish of your choice to match the rest of the décor.

AllClear® glass coating is standard on all of our walk-in panels for ease of cleaning.

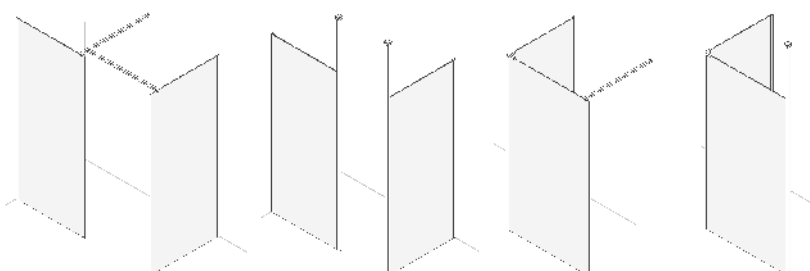



//07 CORNER WALK-IN FIXED DEFLECTOR IN BRUSHED NICKEL



WET ROOM  
OR TRAY  
OPTION

  
LIFETIME  
GUARANTEE

  
FOR A CORNER  
SPACE

  
8mm

  
10mm

# CORNER WETROOM DESIGN WITHOUT DEFLECTOR PANELS

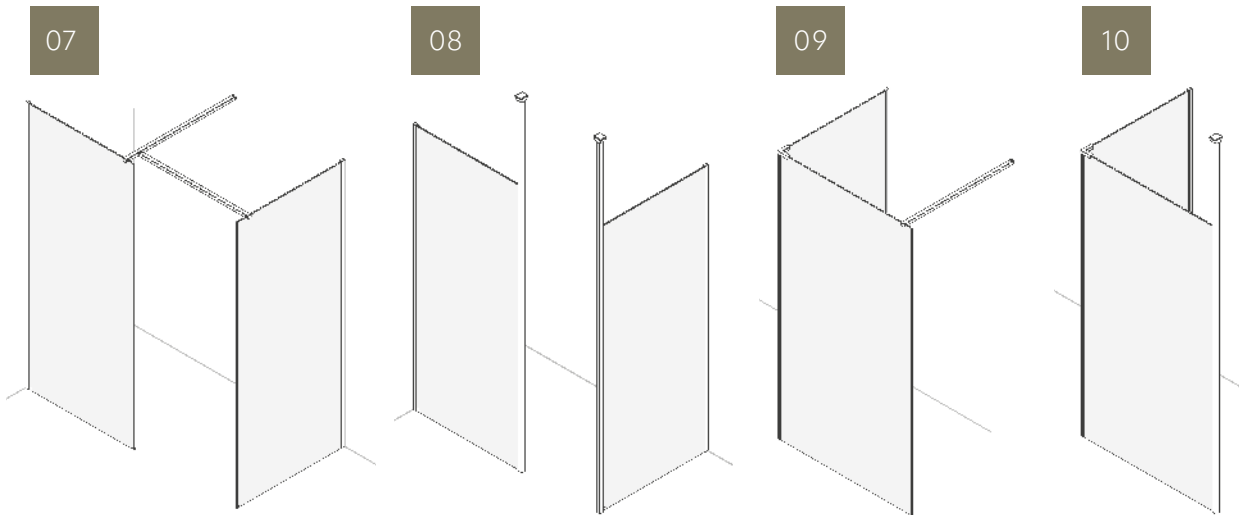

## 8mm

- 2 x Glass G8- ▶
- 2 x Wall Profile WPS ✓
- 2 x Bracing Bar BB1 ✓

## 8mm

- 2 x Glass G8- ▶
- 2 x Wall Profile WPS ✓
- 2 x Bracing Bar F2C8 ✓
- 2 x Ceiling bracket 2CB ✓

## 8mm

- 2 x Glass G8- ▶
- Wall Profile WPS ✓
- Corner Bracket CNR8 ✓
- Corner Seal CNR8SEAL
- Bracing Bar BB1 ✓

## 8mm

- 2 x Glass G8- ▶
- Wall Profile WPS ✓
- Corner Bracket CNR8 ✓
- Corner Seal CNR8SEAL
- Bracing Bar F2C8 ✓
- Ceiling Bracket 2CB ✓

## 10mm

- 2 x Glass G10- ▶
- 2 x Wall Profile WPS ✓
- 2 x Bracing Bar BB1 ✓

## 10mm

- 2 x Glass G10- ▶
- Wall Profile WPS ✓
- Corner Bracket CNR10 ✓
- Corner Seal CNR10SEAL
- Bracing Bar BB1 ✓

KEY: ✓ add colour to code ▶ add size to code



## GLASS PANELS

WIDTH (mm)*	HEIGHT (mm)	8mm GLASS	PRICE	10mm GLASS	PRICE
200	1981	G8-020	£105.13	G10-020	£117.75
300	1981	G8-030	£128.21	G10-030	£143.59
400	1981	G8-040	£150.28	G10-040	£168.31
500	1981	G8-050	£175.33	G10-050	£205.82
600	1981	G8-060	£200.07	G10-060	£236.18
700**	1981	G8-070	£213.90	G10-070	£253.61
800**	1981	G8-080	£236.40	G10-080	£284.69
900**	1981	G8-090	£259.37	G10-090	£310.13
1000**	1981	G8-100	£282.48	G10-100	£338.89
1100**	1981	G8-110	£304.91	G10-110	£366.87
1200**	1981	G8-120	£327.42	G10-120	£394.92
1400**	1981	G8-140	£382.52	N/A	N/A

\*Sizes shown are nominal.  
\*\*Widths indicated are undersized by 48mm to allow for tiling, wall profile (adjustment) and to ensure fit within shower base width.

## WALL PROFILE (UNIVERSAL 8mm AND 10mm GLASS)

DESCRIPTION	HEIGHT (mm)	CODE	SILVER	BLACK	BRUSHED BRASS	BRUSHED NICKEL	BRUSHED BRONZE	GUN METAL
*Add colour suffix to code e.g. WPSB = Black			S	B	BRS	N	BRZ	GUN
20mm Wall Profile with seals	2000	WPS*	£65.02		£71.52			

## 90° CORNER JOINING OPTIONS

DESCRIPTION	HEIGHT (mm)	CODE	SILVER	BLACK	BRUSHED BRASS	BRUSHED NICKEL	BRUSHED BRONZE	GUN METAL
*Add colour suffix to code e.g. CNR8B = Black			S	B	BRS	N	BRZ	GUN
<b>MINIMAL DESIGN</b>								
Corner Bracket 8mm		CNR8*	£35.65		£43.76			
Transparent Corner Seal 8mm	2000	CNR8SEAL	£19.03		£19.03			
Corner Bracket 10mm		CNR10*	£55.23		£64.50			
Transparent Corner Seal 10mm	2000	CNR10SEAL	£19.18		£19.18			
<b>CORNER POST STYLE</b>								
Corner Post 8mm	2000	CP8*	£60.41		£66.69			
Corner Post 10mm	2000	CP10*	£64.10		£70.69			

## BRACING BAR AND OPTIONS

DESCRIPTION	LENGTH (mm)	CODE	SILVER	BLACK	BRUSHED BRASS	BRUSHED NICKEL	BRUSHED BRONZE	GUN METAL
*Add colour suffix to code e.g. BB1B = Black			S	B	BRS	N	BRZ	GUN
<b>DEFAULTS</b>								
Front to back Bracing Bar (includes T joiner)	1200	BB1*	£50.56		£58.88			
Floor to Ceiling Post 8mm	2600	F2C8*	£95.15		£110.38			
Ceiling Bracket		2CB*	£21.78		£30.79			
<b>OPTIONS</b>								
Glass to Ceiling Brace	600	G2C*	£55.45		£68.95			
Ceiling Bracket		2CB*	£21.78		£30.79			
Angled Bracing Bar	600	AB*	£82.56		£92.72			



//BRACING BAR OPTIONS



//FULL HEIGHT CORNER POST

//MINIMAL CORNER BRACKET

All Prices are inclusive of VAT.

//11 CORNER WALK-IN WITH HINGED DEFLECTOR  
IN BRUSHED BRASS



//13 CORNER WALK-IN WITH FIXED DEFLECTOR  
PANEL IN BRUSHED BRONZE



//14 CORNER/2 SIDED WALK-IN WITH FIXED  
DEFLECTOR IN BRUSHED NICKEL



WET ROOM  
OR TRAY  
OPTION

  
**LIFETIME  
GUARANTEE**

  
FOR A CORNER  
SPACE

  
8mm

  
10mm

# CORNER WETROOM DESIGN WITH DEFLECTOR PANELS



//12 CORNER WALK-IN WITH FULL HEIGHT  
DEFLECTOR IN SILVER



//15 CORNER WALK-IN WITH FULL HEIGHT  
DEFLECTOR IN GUN METAL

For smaller corner bathrooms or for that 'spa' look, one of our elegant corner walk-in options with a practical deflector panel can create the perfect personalised showering space. The additional panel can often make the showering area feel a little warmer once the shower has been turned off.

Choose from a fixed deflector panel or one of two rotating deflector hinged panels, and select one of six beautiful bracing bar finishes depending on your requirements. All rotating deflector panels can be retro fitted.

AllClear® glass coating is standard on all of our walk-in panels for ease of cleaning.

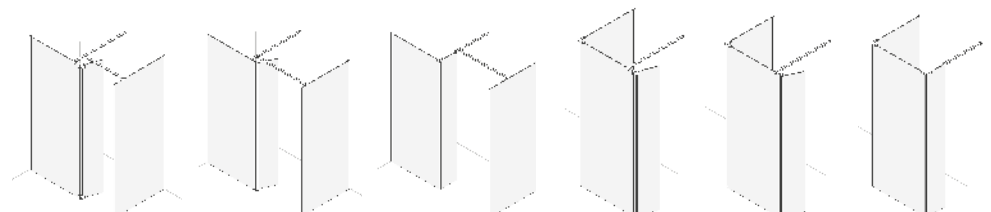

# CORNER WETROOM DESIGN WITH DEFLECTOR PANELS

11

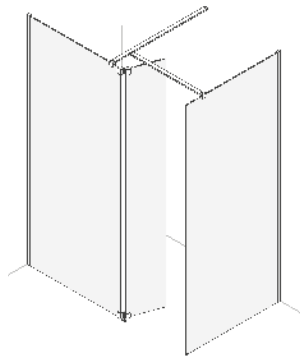

12

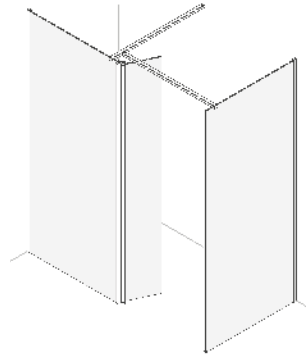

13

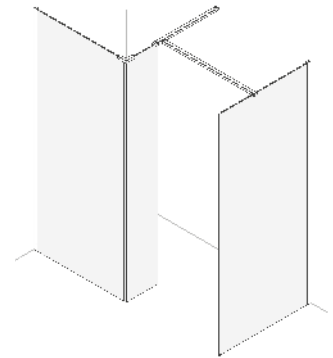

Left hand hinge shown

**8mm**

- 2 x Glass G8- ▶
- 2 x Wall Profile WPS ✓
- 2 x Bracing Bar BB2 ✓
- Hinge Kit PH ✕ ✓
- Glass & Seal PHG8-030

**8mm**

- 2 x Glass G8- ▶
- 2 x Wall Profile WPS ✓
- 2 x Bracing Bar BB1 ✓
- Profile Deflector BY8-3 ✓

**8mm**

- 3 x Glass G8- ▶
- 2 x Wall Profile WPS ✓
- Bracing Bar BB3 ✓
- Bracing Bar BB1 ✓
- Corner Bracket CNR8 ✓
- Corner Seal CNR8SEAL

**10mm**

- 2 x Glass G10- ▶
- 2 x Wall Profile WPS ✓
- 2 x Bracing Bar BB2 ✓
- Hinge Kit PH ✕ ✓
- Glass & Seal PHG10-030

**10mm**

- 2 x Glass G10- ▶
- 2 x Wall Profile WPS ✓
- 2 x Bracing Bar BB1 ✓
- Profile Deflector BY10-3 ✓

**10mm**

- 3 x Glass G10- ▶
- 2 x Wall Profile WPS ✓
- Bracing Bar BB3 ✓
- Bracing Bar BB1 ✓
- Corner Bracket CNR10 ✓
- Corner Seal CNR10SEAL

**KEY:** ✓ add colour to code ▶ add size to code ✕ add L or R to code for left or right handed option



14

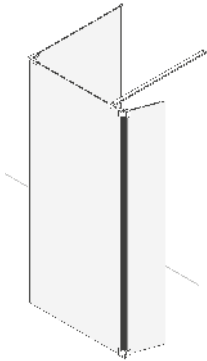

15

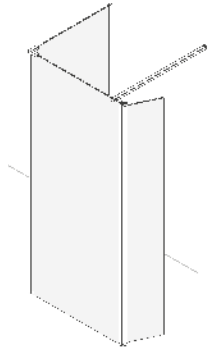

16

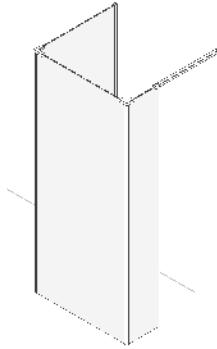

Left hand hinge shown

- |  |  |   |
|--|--|---|
| <p><b>8mm</b></p> <ul style="list-style-type: none"> <li>■ 2 x Glass G8- ▶</li> <li>■ Wall Profile WPS ✓</li> <li>■ Bracing Bar BB2 ✓</li> <li>■ Corner Bracket CNR8 ✓</li> <li>■ Corner Seal CNR8SEAL</li> <li>■ Hinge Kit PH<sup>✕</sup> ✓</li> <li>■ Glass &amp; Seal PHG8-030</li> </ul> | <p><b>8mm</b></p> <ul style="list-style-type: none"> <li>■ 2 x Glass G8- ▶</li> <li>■ Wall Profile WPS ✓</li> <li>■ Corner Bracket CNR8 ✓</li> <li>■ Corner Seal CNR8SEAL</li> <li>■ Profile Deflector BY8-3 ✓</li> <li>■ Bracing Bar BB1 ✓</li> </ul> | <p><b>8mm</b></p> <ul style="list-style-type: none"> <li>■ 3 x Glass G8- ▶</li> <li>■ 2 x Corner Bracket CNR8 ✓</li> <li>■ 2 x Corner Seal CNR8SEAL</li> <li>■ Wall Profile WPS ✓</li> <li>■ Bracing Bar BB3 ✓</li> </ul> |
|--|--|---|

- |   |   |   |
|---|---|---|
| <p><b>10mm</b></p> <ul style="list-style-type: none"> <li>■ 2 x Glass G10- ▶</li> <li>■ Wall Profile WPS ✓</li> <li>■ Bracing Bar BB2 ✓</li> <li>■ Corner Bracket CNR10 ✓</li> <li>■ Corner Seal CNR10SEAL</li> <li>■ Hinge Kit PH<sup>✕</sup> ✓</li> <li>■ Glass &amp; Seal PHG10-030</li> </ul> | <p><b>10mm</b></p> <ul style="list-style-type: none"> <li>■ 2 x Glass G10- ▶</li> <li>■ Wall Profile WPS ✓</li> <li>■ Corner Bracket CNR10 ✓</li> <li>■ Corner Seal CNR10SEAL</li> <li>■ Profile Deflector BY10-3 ✓</li> <li>■ Bracing Bar BB1 ✓</li> </ul> | <p><b>10mm</b></p> <ul style="list-style-type: none"> <li>■ 3 x Glass G10- ▶</li> <li>■ 2 x Corner Bracket CNR10 ✓</li> <li>■ 2 x Corner Seal CNR10SEAL</li> <li>■ Wall Profile WPS ✓</li> <li>■ Bracing Bar BB3 ✓</li> </ul> |
|---|---|---|

**KEY:** ✓ add colour to code ▶ add size to code ✕ add L or R to code for left or right handed option



# CORNER WETROOM DESIGN WITH DEFLECTOR PANELS

//11 CORNER WALK-IN WITH HINGED  
DEFLECTOR IN BRUSHED BRASS



//16 CORNER/2 SIDED WALK-IN WITH  
FIXED DEFLECTOR IN BRUSHED BRASS



## GLASS PANELS

WIDTH (mm)*	HEIGHT (mm)	8mm GLASS	PRICE	10mm GLASS	PRICE
200	1981	G8-020	£105.13	G10-020	£117.75
300	1981	G8-030	£128.21	G10-030	£143.59
400	1981	G8-040	£150.28	G10-040	£168.31
500	1981	G8-050	£175.33	G10-050	£205.82
600	1981	G8-060	£200.07	G10-060	£236.18
700**	1981	G8-070	£213.90	G10-070	£253.61
800**	1981	G8-080	£236.40	G10-080	£284.69
900**	1981	G8-090	£259.37	G10-090	£310.13
1000**	1981	G8-100	£282.48	G10-100	£338.89
1100**	1981	G8-110	£304.91	G10-110	£366.87
1200**	1981	G8-120	£327.42	G10-120	£394.92
1400**	1981	G8-140	£382.52	N/A	N/A

\*Sizes shown are nominal.  
 \*\*Widths indicated are undersized by 48mm to allow for tiling, wall profile (adjustment) and to ensure fit within shower base width.

## WALL PROFILE (UNIVERSAL 8mm AND 10mm GLASS)

DESCRIPTION	HEIGHT (mm)	CODE	SILVER	BLACK	BRUSHED BRASS	BRUSHED NICKEL	BRUSHED BRONZE	GUN METAL
*Add colour suffix to code e.g. WPSB = Black			S	B	BRS	N	BRZ	GUN
20mm Wall Profile with seals	2000	WPS*	£65.02		£71.52			

## 90° CORNER JOINING OPTIONS (INCLUDING FIXED DEFLECTOR)

DESCRIPTION	HEIGHT (mm)	CODE	SILVER	BLACK	BRUSHED BRASS	BRUSHED NICKEL	BRUSHED BRONZE	GUN METAL
*Add colour suffix to code e.g. CNR8B = Black			S	B	BRS	N	BRZ	GUN
<b>MINIMAL DESIGN</b>								
Corner Bracket 8mm		CNR8*	£35.65		£43.76			
Transparent Corner Seal 8mm	2000	CNR8SEAL	£19.03		£19.03			
Corner Bracket 10mm		CNR10*	£55.23		£64.50			
Transparent Corner Seal 10mm	2000	CNR10SEAL	£19.18		£19.18			
<b>CORNER POST STYLE</b>								
Corner Post 8mm	2000	CP8*	£60.41		£66.69			
Corner Post 10mm	2000	CP10*	£64.10		£70.69			
<b>FIXED DEFLECTOR BRACING</b>								
Inline Bracing Bar	1200	BB3*	£49.63		£59.64			

## 180° MINIMAL STYLE 300mm HINGE DEFLECTOR (8mm AND 10mm GLASS)

DESCRIPTION	HEIGHT (mm)	CODE	SILVER	BLACK	BRUSHED BRASS	BRUSHED NICKEL	BRUSHED BRONZE	GUN METAL
*Add colour suffix to code e.g. PHLB = Black			S	B	BRS	N	BRZ	GUN
<b>MINIMAL STYLE</b>								
Hinge Set LH (as shown)		PHL*	£115.86		£132.28			
Hinge Set RH (opposite shown)		PHR*	£115.86		£132.28			
Deflector Glass and Transparent Seal 8mm	2000	PHG8-030	£128.21		£128.21			
Deflector Glass and Transparent Seal 10mm	2000	PHG10-030	£140.49		£140.49			
<b>BRACING DEFAULT</b>								
Front to back Bracing Bar (for minimalist hinge - includes T joiner)	1200	BB2*	£54.56		£60.37			

## 270° FULL HEIGHT 300mm HINGE DEFLECTOR (8mm AND 10mm GLASS)

DESCRIPTION	HEIGHT (mm)	CODE	SILVER	BLACK	BRUSHED BRASS	BRUSHED NICKEL	BRUSHED BRONZE	GUN METAL
*Add colour suffix to code e.g. BY8B = Black			S	B	BRS	N	BRZ	GUN
Full Height Hinge Deflector Assembly 8mm	2000	BY8*	£239.15		£263.06			
Full Height Hinge Deflector Assembly 10mm	2000	BY10*	£249.83		£274.82			
<b>BRACING DEFAULT</b>								
Front to back Bracing Bar (includes T joiner)	1200	BB1*	£50.56		£58.88			

## BRACING OPTIONS

DESCRIPTION	LENGTH (mm)	CODE	SILVER	BLACK	BRUSHED BRASS	BRUSHED NICKEL	BRUSHED BRONZE	GUN METAL
*Add colour suffix to code e.g. G2CB = Black			S	B	BRS	N	BRZ	GUN
Glass to Ceiling Brace	600	G2C*	£55.45		£68.95			
Floor to Ceiling Post 8mm	2600	F2C8*	£95.16		£110.38			
Ceiling Bracket		2CB*	£21.78		£30.79			
Optional Foot Kit (for Fixed Deflector)	2000	FTK*	£22.18		£31.96			

Foot Kit recommended when fixed deflector glass is over tray recess

All Prices are inclusive of VAT.

//19 SINGLE PANEL WALK-IN FLOOR TO CEILING BRACE IN GUN METAL



//18 CORNER SINGLE PANEL WITH CEILING BRACING BAR IN GUN METAL



//17 SINGLE PANEL WALK-IN IN BRUSHED BRONZE



//20 WALK-IN PANEL WITH ANGLED BRACING BAR IN BRUSHED BRASS

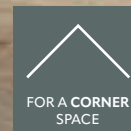
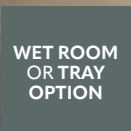

# WETROOM PANEL DESIGN WITHOUT DEFLECTOR PANELS



Even traditionally smaller British bathrooms can be personalised to create a wonderful showering space.

Lakes' simple yet refined walk-in panels are at home in any recess area. Within our extensive range of 8mm and 10mm toughened safety glass panels, you will find a size solution that suits the look and showering experience you're trying to create.

Then, simply choose one of our elegant bracing bar solutions [the floor to ceiling option is a firm favourite] to create the safest and sleekest glass panel arrangement. The glass height will add to the impression of space and enhanced light even in the tightest of spaces. Wall profiles and bracing bars are all available in a choice of six fabulous finishes.

AllClear® glass coating is standard on all of our walk-in panels for ease of cleaning.

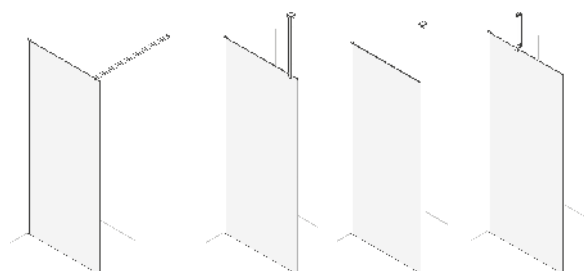

# WETROOM PANEL DESIGN WITHOUT DEFLECTOR PANELS

17

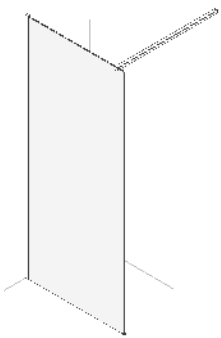

18

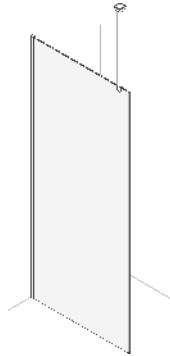

19

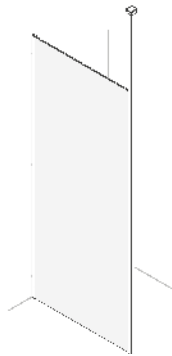

20

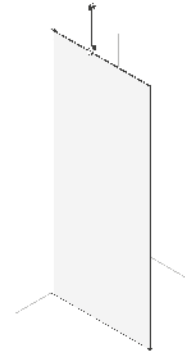

**8mm**

- Glass G8- ▶
- Wall Profile WPS ✓
- Bracing Bar BB1 ✓

**8mm**

- Glass G8- ▶
- Wall Profile WPS ✓
- Bracing Bar G2C
- Ceiling Bracket 2CB ✓

**8mm**

- Glass G8- ▶
- 2 x Bracing Bar F2C8 ✓
- 2 x Ceiling Bracket 2CB ✓

**8mm**

- Glass G8- ▶
- Wall Profile WPS ✓
- Bracing Bar AB ✓

**10mm**

- Glass G10- ▶
- Wall Profile WPS ✓
- Bracing Bar BB1 ✓

**10mm**

- Glass G10- ▶
- Wall Profile WPS ✓
- Bracing Bar G2C10 ✓
- Ceiling Bracket 2CB ✓

**10mm**

- Glass G10- ▶
- Wall Profile WPS ✓
- Bracing Bar AB ✓

KEY: ✓ add colour to code ▶ add size to code



### GLASS PANELS

WIDTH (mm)*	HEIGHT (mm)	8mm GLASS	PRICE	10mm GLASS	PRICE
200	1981	G8-020	£105.13	G10-020	£117.75
300	1981	G8-030	£128.21	G10-030	£143.59
400	1981	G8-040	£150.28	G10-040	£168.31
500	1981	G8-050	£175.33	G10-050	£205.82
600	1981	G8-060	£200.07	G10-060	£236.18
700**	1981	G8-070	£213.90	G10-070	£253.61
800**	1981	G8-080	£236.40	G10-080	£284.69
900**	1981	G8-090	£259.37	G10-090	£310.13
1000**	1981	G8-100	£282.48	G10-100	£338.89
1100**	1981	G8-110	£304.91	G10-110	£366.87
1200**	1981	G8-120	£327.42	G10-120	£394.92
1400**	1981	G8-140	£382.52	N/A	N/A

\*Sizes shown are nominal.  
 \*\*Widths indicated are undersized by 48mm to allow for tiling, wall profile (adjustment) and to ensure fit within shower base width.

### WALL PROFILE (UNIVERSAL 8mm AND 10mm GLASS)

DESCRIPTION	HEIGHT (mm)	CODE	SILVER	BLACK	BRUSHED BRASS	BRUSHED NICKEL	BRUSHED BRONZE	GUN METAL
*Add colour suffix to code e.g. WPSB = Black			S	B	BRS	N	BRZ	GUN
20mm Wall Profile with seals	2000	WPS*	£65.02				£71.52	

### BRACING BAR OPTIONS

DESCRIPTION	LENGTH (mm)	CODE	SILVER	BLACK	BRUSHED BRASS	BRUSHED NICKEL	BRUSHED BRONZE	GUN METAL
*Add colour suffix to code e.g. BB1B = Black			S	B	BRS	N	BRZ	GUN
Front to back Bracing Bar (includes T joiner)	1200	BB1*	£50.56				£58.88	
Glass to Ceiling Brace	600	G2C*	£55.45				£68.95	
Floor to Ceiling Post 8mm	2600	F2C8*	£95.15				£110.38	
Ceiling Bracket		2CB*	£21.78				£30.79	
Angled Bracing Bar	600	AB*	£82.56				£92.72	



//BRACING BAR OPTIONS



//FULL HEIGHT CORNER POST

//MINIMAL CORNER BRACKET

All Prices are inclusive of VAT.

//21 WALK-IN WITH HINGED DEFLECTOR IN BRUSHED BRASS



38

WET ROOM  
OR TRAY  
OPTION

  
LIFETIME  
GUARANTEE

  
FOR AN ALCOVE  
SPACE

  
FOR A CORNER  
SPACE

  
8mm

  
10mm

# WETROOM PANEL DESIGN WITH DEFLECTOR PANELS

To ensure that the water spray stays within the walk-in showering area and the rest of the bathroom stays dry, choose from one of our elegant deflector panels. Our contemporary fixed panel or rotating panels (which can be neatly folded away) are superbly engineered and will add practicality and visual appeal to your showering space. All rotating deflector panels can also be retro fitted.

All deflector fittings are available in our palette of 6 colour finishes and all glass panels features AllClear® glass coating is standard on all of our walk-in panels for ease of cleaning.



//23 SINGLE PANEL WITH FIXED DEFLECTOR  
IN BRUSHED BRONZE



//22 SINGLE PANEL WALK-IN WITH FULL HEIGHT  
DEFLECTOR IN SILVER

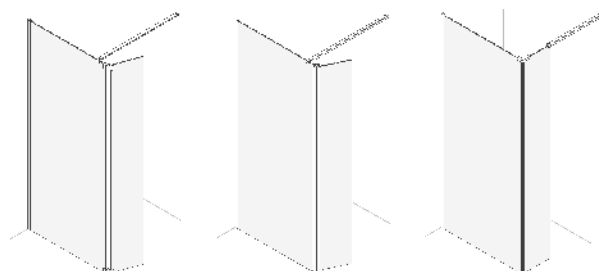



# WETROOM PANEL DESIGN WITH DEFLECTOR PANELS

21

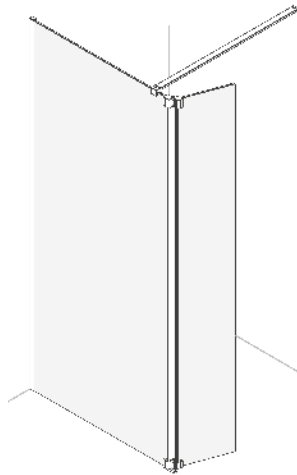

22

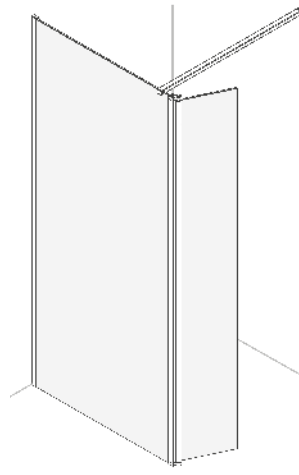

23

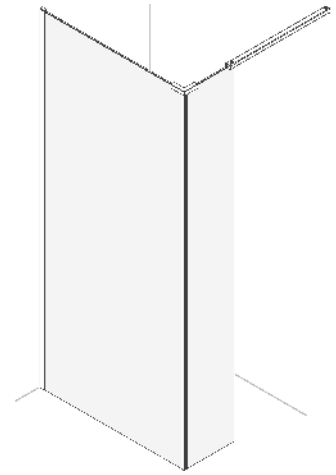

Left hand hinge shown

**8mm**

- Glass G8- ▶
- Wall Profile WPS ✓
- Hinge Kit PH ✕ ✓
- Glass & Seal PHG8-030
- Bracing Bar BB2 ✓

**8mm**

- Glass G8- ▶
- Wall Profile WPS ✓
- Profile Deflector BY8-3 ✓
- Bracing Bar BB1 ✓

**8mm**

- 2 x Glass G8- ▶
- Wall Profile WPS ✓
- Corner Bracket CNR8 ✓
- Corner Seal CNR8SEAL
- Bracing Bar BB3 ✓

**10mm**

- Glass G10- ▶
- Wall Profile WPS ✓
- Hinge Kit PH ✕ ✓
- Glass & Seal PHG10-030
- Bracing Bar BB2 ✓

**10mm**

- Glass G10- ▶
- Wall Profile WPS ✓
- Profile Deflector BY10-3 ✓
- Bracing Bar BB1 ✓

**10mm**

- 2 x Glass G10- ▶
- Wall Profile WPS ✓
- Corner Bracket CNR10 ✓
- Corner Seal CNR10SEAL
- Bracing Bar BB3 ✓

**KEY:** ✓ add colour to code ▶ add size to code ✕ add L or R to code for left or right handed option



## GLASS PANELS

WIDTH (mm)*	HEIGHT (mm)	8mm GLASS	PRICE	10mm GLASS	PRICE
200	1981	G8-020	£105.13	G10-020	£117.75
300	1981	G8-030	£128.21	G10-030	£143.59
400	1981	G8-040	£150.28	G10-040	£168.31
500	1981	G8-050	£175.33	G10-050	£205.82
600	1981	G8-060	£200.07	G10-060	£236.18
700**	1981	G8-070	£213.90	G10-070	£253.61
800**	1981	G8-080	£236.40	G10-080	£284.69
900**	1981	G8-090	£259.37	G10-090	£310.13
1000**	1981	G8-100	£282.48	G10-100	£338.89
1100**	1981	G8-110	£304.91	G10-110	£366.87
1200**	1981	G8-120	£327.42	G10-120	£394.92
1400**	1981	G8-140	£382.52	N/A	N/A

\*Sizes shown are nominal.  
\*\*Widths indicated are undersized by 48mm to allow for tiling, wall profile (adjustment) and to ensure fit within shower base width.

## WALL PROFILE (UNIVERSAL 8mm AND 10mm GLASS)

DESCRIPTION	HEIGHT (mm)	CODE	SILVER	BLACK	BRUSHED BRASS	BRUSHED NICKEL	BRUSHED BRONZE	GUN METAL
*Add colour suffix to code e.g. WPSB = Black			S	B	BRS	N	BRZ	GUN
20mm Wall Profile with seals	2000	WPS*	£65.02		£71.52			

## FIXED 90° DEFLECTOR

DESCRIPTION	HEIGHT (mm)	CODE	SILVER	BLACK	BRUSHED BRASS	BRUSHED NICKEL	BRUSHED BRONZE	GUN METAL
*Add colour suffix to code e.g. CNR8B = Black			S	B	BRS	N	BRZ	GUN
<b>MINIMAL DESIGN</b>								
Corner Bracket 8mm		CNR8*	£35.65		£43.76			
Transparent Corner Seal 8mm	2000	CNR8SEAL	£19.03		£19.03			
Corner Bracket 10mm		CNR10*	£55.23		£64.50			
Transparent Corner Seal 10mm	2000	CNR10SEAL	£19.18		£19.18			
<b>CORNER POST STYLE</b>								
Corner Post 8mm	2000	CP8*	£60.41		£66.69			
Corner Post 10mm	2000	CP10*	£64.10		£70.69			
<b>FIXED DEFLECTOR BRACING</b>								
Inline Bracing Bar	1200	BB3*	£49.63		£59.64			

## 180° MINIMAL STYLE 300mm HINGE DEFLECTOR (8mm AND 10mm GLASS)

DESCRIPTION	HEIGHT (mm)	CODE	SILVER	BLACK	BRUSHED BRASS	BRUSHED NICKEL	BRUSHED BRONZE	GUN METAL
*Add colour suffix to code e.g. PHLB = Black			S	B	BRS	N	BRZ	GUN
<b>MINIMAL STYLE</b>								
Hinge Set LH (as shown)		PHL*	£115.86		£132.28			
Hinge Set RH (opposite shown)		PHR*	£115.86		£132.28			
Deflector Glass and Transparent Seal 8mm	2000	PHG8-030	£128.21		£128.21			
Deflector Glass and Transparent Seal 10mm	2000	PHG10-030	£140.49		£140.49			
<b>BRACING DEFAULT</b>								
Front to back Bracing Bar (for minimalist hinge - includes T joiner)	1200	BB2*	£54.56		£60.37			

## 270° FULL HEIGHT 300mm HINGE DEFLECTOR (8mm AND 10mm GLASS)

DESCRIPTION	HEIGHT (mm)	CODE	SILVER	BLACK	BRUSHED BRASS	BRUSHED NICKEL	BRUSHED BRONZE	GUN METAL
*Add colour suffix to code e.g. BY8B = Black			S	B	BRS	N	BRZ	GUN
Full Height Hinge Deflector Assembly 8mm	2000	BY8*	£239.15		£263.06			
Full Height Hinge Deflector Assembly 10mm	2000	BY10*	£249.83		£274.82			
<b>BRACING DEFAULT</b>								
Front to back Bracing Bar (includes T joiner)	1200	BB1*	£50.56		£58.88			

## BRACING OPTIONS

DESCRIPTION	LENGTH (mm)	CODE	SILVER	BLACK	BRUSHED BRASS	BRUSHED NICKEL	BRUSHED BRONZE	GUN METAL
*Add colour suffix to code e.g. G2CB = Black			S	B	BRS	N	BRZ	GUN
Glass to Ceiling Brace	600	G2C*	£55.45		£68.95			
Ceiling Bracket		2CB*	£21.78		£30.79			
Angled Bracing Bar	600	AB*	£82.56		£92.72			
Optional Foot Kit (for Fixed Deflector)		FTK*	£22.18		£31.96			

Foot Kit recommended when fixed deflector glass is over tray recess

All Prices are inclusive of VAT.

//28 WALK THROUGH WITH FIXED DEFLECTORS  
IN BRUSHED BRONZE



//27 WALK THROUGH WALK-IN WITH FULL  
HEIGHT DEFLECTOR PANELS IN SILVER



WET ROOM  
OR TRAY  
OPTION

  
**LIFETIME  
GUARANTEE**

  
FOR AN ALCOVE  
SPACE

  
FOR A CORNER  
SPACE

  
8mm

  
10mm

# WALK THROUGH WETROOM DESIGN WITH AND WITHOUT DEFLECTOR PANELS



//26 WALK THROUGH WALK-IN WITH HINGED DEFLECTORS IN GUN METAL



//24 WALK THROUGH DEFLECTOR IN SILVER

You may have seen or even experienced them in hotels, but now you can enjoy a walk-through wet room in your own home. Ideal for installation where space in the bathroom is not an issue and where a standard shower tray size isn't what you're looking for. Perfect on a tiled floor, we recommend allowing around 500mm minimum access width on both sides.

And, our selection of stunning, secure and practical bracing bars, available in a choice of colour finishes, will complement your bathroom décor and styling.

And if you want to add a deflector panel, choose one of our fixed or rotating panel sizes to suit you and help keep the water within the walk through area. All rotating deflector panels can be retro fitted.

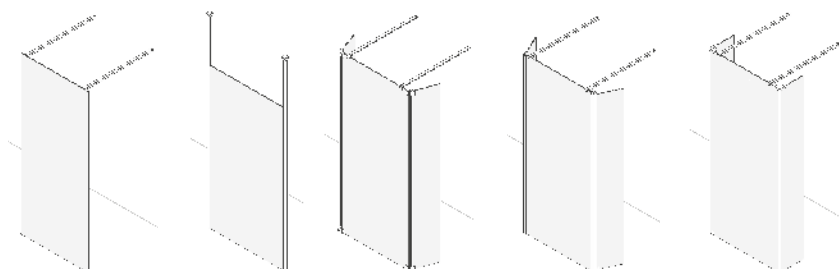

WALK THROUGH  
WETROOM DESIGN  
WITH AND WITHOUT  
DEFLECTOR PANELS

# WALK THROUGH WETROOM DESIGN WITH AND WITHOUT DEFLECTOR PANELS

24

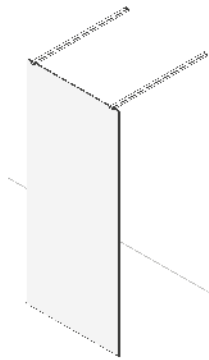

**8mm**

- Glass G8- ▶
- 2 x Bracing Bar BB1 ✓

25

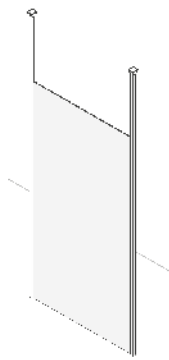

**8mm**

- Glass G8- ▶
- 2 x Bracing Bar F2C8 ✓
- 2 x Ceiling Bracket 2CB ✓

26

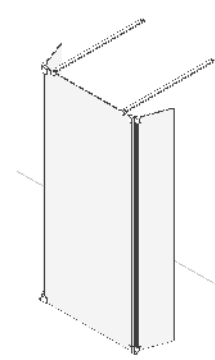

**8mm**

- Glass G8- ▶
- 2 x Bracing Bar BB2 ✓
- 2 x Glass & Seal PHG8-030
- Hinge Kit PHL ✓
- Hinge Kit PHR ✓

**10mm**

- Glass G10- ▶
- 2 x Bracing Bar BB1 ✓

**10mm**

- Glass G10- ▶
- 2 x Bracing Bar BB2 ✓
- 2 x Glass & Seal PHG10-030
- Hinge Kit PHL ✓
- Hinge Kit PHR ✓

KEY: ✓ add colour to code ▶ add size to code

27

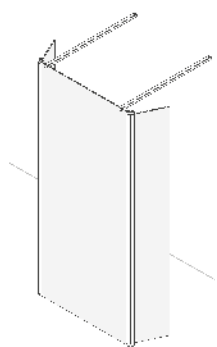

**8mm**

- Glass G8- ▶
- 2x Profile Deflector BY8-3 ✓
- 2x Bracing Bar BB1 ✓

28

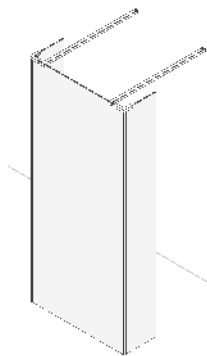

**8mm**

- 3 x Glass G8- ▶
- 2 x Corner Bracket CNR8 ✓
- 2 x Corner Seal CNR8SEAL
- 2 x Bracing Bar BB1 ✓

**10mm**

- Glass G10- ▶
- 2x Profile Deflector BY10-3 ✓
- 2 x Bracing Bar BB1 ✓

**10mm**

- 3 x Glass G10- ▶
- 2 x Corner Bracket CNR10 ✓
- 2 x Corner Seal CNR10SEAL
- 2 x Bracing Bar BB1 ✓

**KEY:** ✓ add colour to code ▶ add size to code





//27 WALK-THROUGH WALK-IN WITH FULL  
HEIGHT DEFLECTOR PANELS IN SILVER

# WALK THROUGH WETROOM DESIGN WITH AND WITHOUT DEFLECTOR PANELS



//24 WALK-IN PANEL IN BRUSHED NICKEL

## GLASS PANELS

WIDTH (mm)*	HEIGHT (mm)	8mm GLASS	PRICE	10mm GLASS	PRICE
200	1981	G8-020	£105.13	G10-020	£117.75
300	1981	G8-030	£128.21	G10-030	£143.59
400	1981	G8-040	£150.28	G10-040	£168.31
500	1981	G8-050	£175.33	G10-050	£205.82
600	1981	G8-060	£200.07	G10-060	£236.18
700**	1981	G8-070	£213.90	G10-070	£253.61
800**	1981	G8-080	£236.40	G10-080	£284.69
900**	1981	G8-090	£259.37	G10-090	£310.13
1000**	1981	G8-100	£282.48	G10-100	£338.89
1100**	1981	G8-110	£304.91	G10-110	£366.87
1200**	1981	G8-120	£327.42	G10-120	£394.92
1400**	1981	G8-140	£382.52	N/A	N/A

\*Sizes shown are nominal.  
 \*\*Widths indicated are undersized by 48mm to allow for tiling, wall profile (adjustment) and to ensure fit within shower base width.

## FIXED 90° DEFLECTOR

DESCRIPTION	HEIGHT (mm)	CODE	SILVER	BLACK	BRUSHED BRASS	BRUSHED NICKEL	BRUSHED BRONZE	GUN METAL
*Add colour suffix to code e.g. CNR8B = Black			S	B	BRS	N	BRZ	GUN
<b>MINIMAL DESIGN</b>								
Corner Bracket 8mm		CNR8*	£35.65			£43.76		
Transparent Corner Seal 8mm	2000	CNR8SEAL	£19.03			£19.03		
Corner Bracket 10mm		CNR10*	£55.23			£64.50		
Transparent Corner Seal 10mm	2000	CNR10SEAL	£19.18			£19.18		
<b>CORNER POST STYLE</b>								
Corner Post 8mm	2000	CP8*	£60.41			£66.69		
Corner Post 10mm	2000	CP10*	£64.10			£70.69		
<b>BRACING DEFAULT</b>								
Front to back Bracing Bar (includes T joiner)	1200	BB1*	£50.56			£58.88		

## 180° MINIMAL STYLE 300mm HINGE DEFLECTOR (8mm AND 10mm GLASS)

DESCRIPTION	HEIGHT (mm)	CODE	SILVER	BLACK	BRUSHED BRASS	BRUSHED NICKEL	BRUSHED BRONZE	GUN METAL
*Add colour suffix to code e.g. PHLB = Black			S	B	BRS	N	BRZ	GUN
<b>MINIMAL STYLE</b>								
Hinge Set LH (as shown)		PHL*	£115.86			£132.28		
Hinge Set RH (opposite shown)		PHR*	£115.86			£132.28		
Deflector Glass and Transparent Seal 8mm	2000	PHG8-030	£128.21			£128.21		
Deflector Glass and Transparent Seal 10mm	2000	PHG10-030	£140.49			£140.49		
<b>BRACING DEFAULT</b>								
Front to back Bracing Bar (for minimalist hinge - includes T joiner)	1200	BB2*	£54.56			£60.37		

## 270° FULL HEIGHT 300mm HINGE DEFLECTOR (8mm AND 10mm GLASS)

DESCRIPTION	HEIGHT (mm)	CODE	SILVER	BLACK	BRUSHED BRASS	BRUSHED NICKEL	BRUSHED BRONZE	GUN METAL
*Add colour suffix to code e.g. BY8B = Black			S	B	BRS	N	BRZ	GUN
Full Height Hinge Deflector Assembly 8mm	2000	BY8*	£239.15			£263.06		
Full Height Hinge Deflector Assembly 10mm	2000	BY10*	£249.83			£274.82		
<b>BRACING DEFAULT</b>								
Front to back Bracing Bar (includes T joiner)	1200	BB1*	£50.56			£58.88		

## BRACING OPTIONS

DESCRIPTION	LENGTH (mm)	CODE	SILVER	BLACK	BRUSHED BRASS	BRUSHED NICKEL	BRUSHED BRONZE	GUN METAL
*Add colour suffix to code e.g. F2C8B = Black			S	B	BRS	N	BRZ	GUN
Floor to Ceiling Post 8mm	2600	F2C8*	£95.15			£110.38		
Ceiling Bracket		2CB*	£21.78			£30.79		
Optional Foot Kit (for Fixed Deflector)		FTK*	£22.187			£31.96		

Foot Kit recommended when fixed deflector glass is over tray recess

All Prices are inclusive of VAT.

# AMBIENT WALK WETROOM DESIGN WITH AND WITHOUT DEFLECTOR PANELS

The Ambient walk-in is the first showering space of its kind. Featuring a PIR motion sensor that triggers the built-in LED lighting concealed in the wall mount, it emits a soft glow of light along the edge of the walk-in panel. The ambience of the bathroom is subtly transformed using soft lighting gently illuminating the room, so night-time visits to the bathroom are safer for all.

Within the showering area, the soft light created by the Ambient walk-in makes the experience calming, soothing and restful. Become lost in the moment and let the ambience relax and transport you to your own private sanctuary.

The Ambient walk-in features 8mm toughened safety glass with AllClear® glass coating is standard on all of our walk-in panels for ease of cleaning.

48

## AMBIENT

WIDTH (mm)**	HEIGHT (mm)*	WIDTH ADJUSTMENT (mm)	WALL PROFILE LED AND DRIVER		GLASS AND BOTTOM TRIM	PRICE SILVER
			LEFT	RIGHT		
700	2000	685 - 700	LK869-LS	LK869-RS	LK869-070S	£506.91
800	2000	785 - 800			LK869-080S	£532.07
900	2000	885 - 900			LK869-090S	£550.93
1000	2000	985 - 1000			LK869-100S	£650.30
1100	2000	1085 - 1100			LK869-110S	£685.52
1200	2000	1185 - 1200			LK869-120S	£724.52
1400	2000	1385 - 1400			LK869-140S	£811.31

\*Sizes shown are nominal.  
Silver colour ONLY. Wall mount kits contain all electrical / finishing items.

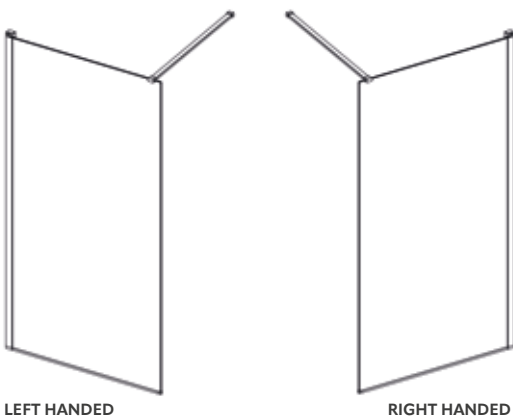

- IP67 rated
- Complete with 12VDC SELV driver, for complete bathroom safety
- Warm White light temperature 2700-3000K
- PIR cuts out 3 minutes after the last activation





//SILVER



WET ROOM  
OR TRAY  
OPTION

  
**LIFETIME  
GUARANTEE**

  
FOR AN ALCOVE  
SPACE

  
FOR A CORNER  
SPACE

  
8mm

//HORIZON SINGLE PANEL WALK-IN

50



WET ROOM  
OR TRAY  
OPTION

  
LIFETIME  
GUARANTEE

  
FOR AN ALCOVE  
SPACE

  
FOR A CORNER  
SPACE

  
8mm

# HORIZON WALK WETROOM DESIGN WITH AND WITHOUT DEFLECTOR PANELS



//HORIZON HINGED BYPASS PANEL

Stylish and modern, the matt black finish of the Horizon walk-in creates the high impact look of a statement showering space. The simplicity of design, clean lines and striking, industrial-looking, horizon graphics on the glass, combine to make a bold and contemporary feel. The deep matt black profiles accentuate the height of the glass.

The horizon graphic design is applied using an advanced "ceramic-print" technology making it great for bathrooms, easy to clean, and long-lasting. The Horizon walk-in features 8mm toughened safety glass with AllClear® glass coating is standard on all of our walk-in panels for ease of cleaning.

## FRONT AND SIDE PANELS

DESCRIPTION	WIDTH (mm)**	HEIGHT (mm)*	WIDTH ADJUSTMENT (mm)	CODE	PRICE MATT BLACK
8mm Ceramic Printed Glass Panel	800	2000	755-770	LK851-080	£532.07
8mm Ceramic Printed Glass Panel	900	2000	855-873	LK851-090	£550.93
8mm Ceramic Printed Glass Panel	1000	2000	955-970	LK851-100	£650.30
8mm Ceramic Printed Glass Panel	1100	2000	1065-1080	LK851-110	£685.52
8mm Ceramic Printed Glass Panel	1200	2000	1165-1080	LK851-120	£724.52

\*Sizes shown are nominal.

\*\*All widths are undersized by 45mm to allow for tiling when fitting to shower trays.  
Supplied complete with glass to wall bracing bar

## FULL HEIGHT 180° DEFLECTOR AND PANEL

DESCRIPTION	WIDTH (mm)**	HEIGHT (mm)*	WIDTH ADJUSTMENT (mm)	CODE	PRICE MATT BLACK
Full Height Rotating Hinge 8mm with 300mm panel	300	2000	NA	LK852-30	£349.99

\*Sizes shown are nominal.

Deflector panel rotates 180° inwards/90° outwards

Note: The deflector panel will increase the width of the front panel by 15mm

## OPTIONAL PRODUCTS

DESCRIPTION	CODE	PRICE MATT BLACK
Black 90° Bar Joining Kit for Side Panel	10CSS-62B	£53.93
Black Extended Bracing Bar (1200mm - bar only)	10CSS-602B-120	£59.43
Glass to Ceiling Bracing Bar	GC2B	£55.45
Extension Profile 20mm	LK8LEPB	£33.02
Ceiling bracket	2CBB	£21.78

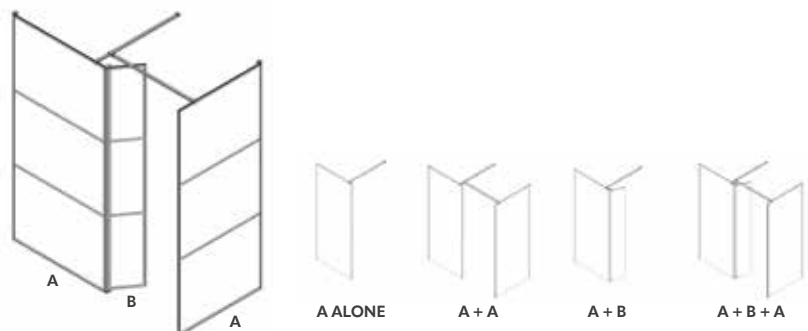

# PLAN YOUR OWN PERSONAL SHOWERING SPACE

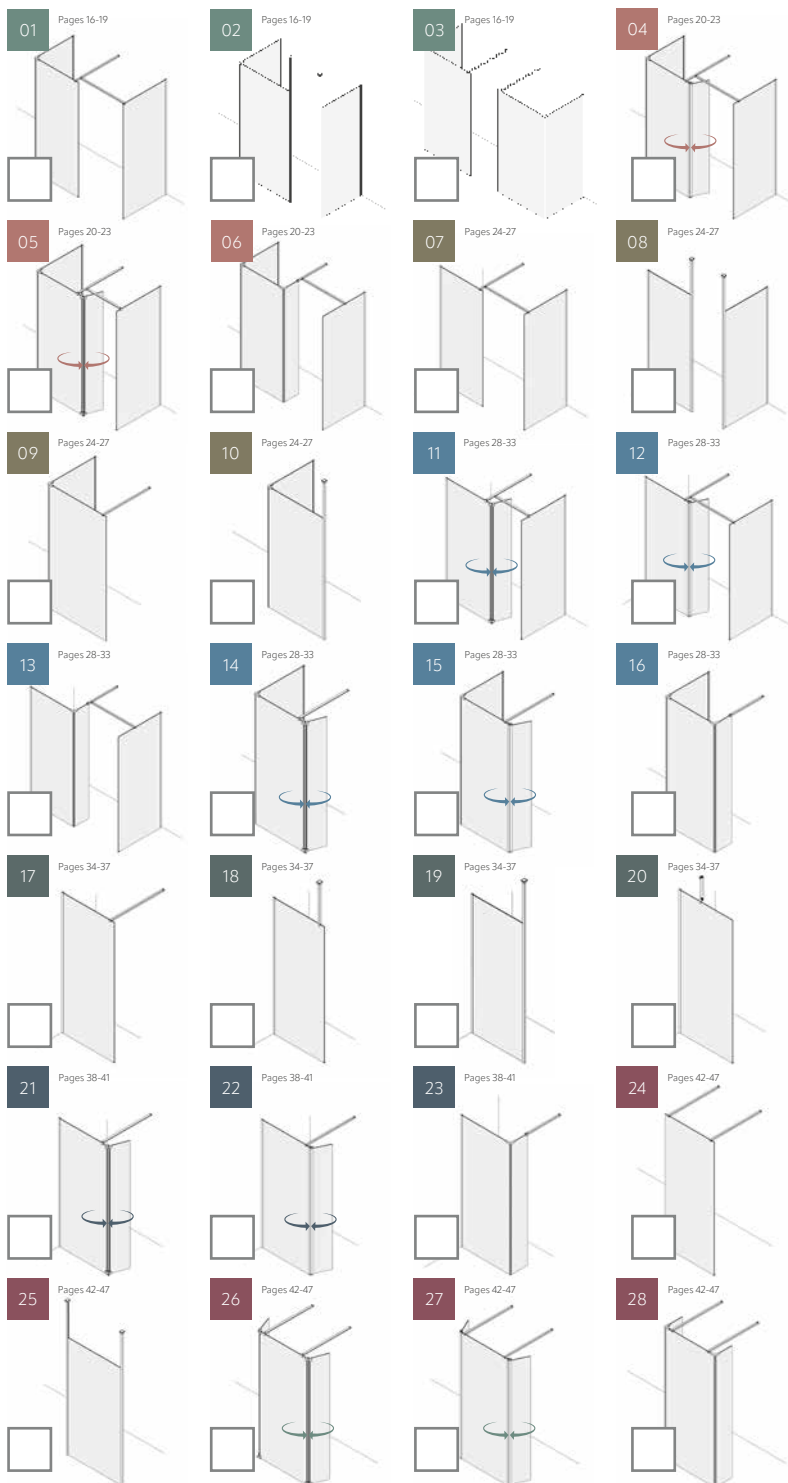

**Tick the box next to your  
chosen configuration**

## //HINTS AND TIPS



- We advise taking the measurements at least twice to check they're correct.
- When measuring the space ensure the dimension includes final wall covering/tiles.
- We recommend allowing a minimum 500mm access gap between panels.
- If you're choosing a full height hinged deflector panel, make sure you have enough space outside and inside of the showering space to open and close the panel.
- If the glass is installed on a shower tray, ensure the tray has a minimum flat ledge of 40mm.
- When measuring, it's not unusual to find some walls are not 100% straight for their entire height. Lakes wall profiles offer up to 20mm adjustment.
- If you're replacing an existing shower enclosure and shower tray, check there haven't been any water leaks and that the intended floor area or tray is sound.
- Check the position and height of the shower valve, shower head etc to ensure all users can comfortably access the controls and shower head.

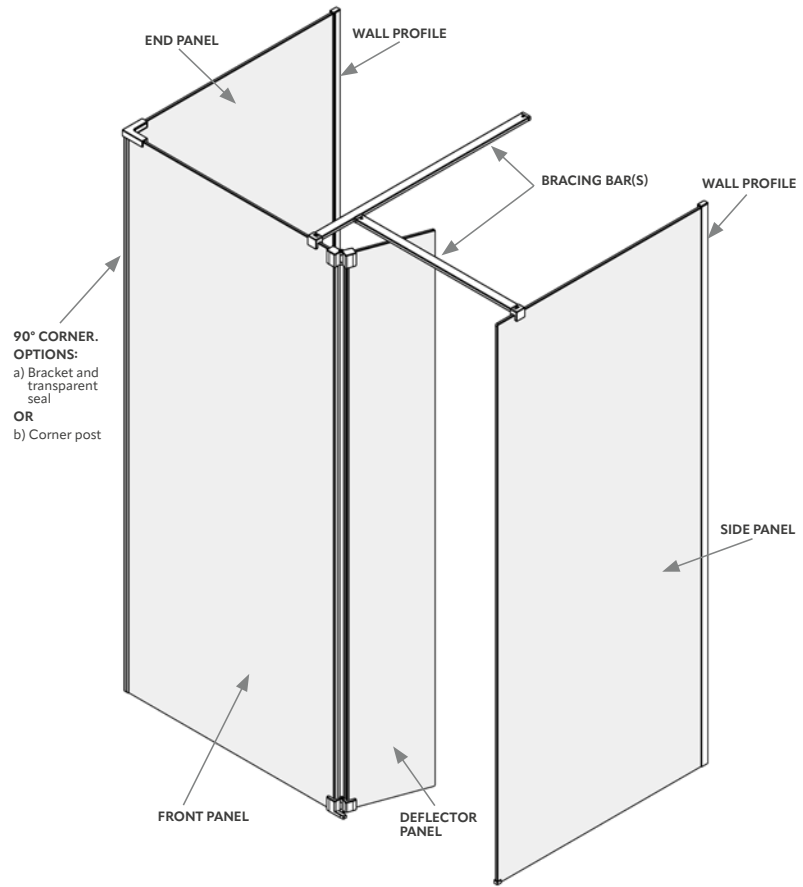

Once you have chosen your preferred walk-in layout, you can sketch out on the next page.

Detail in the form below all the glass and metallic parts you require for your individual Lakes walk-in design and hand to your retailer.

**Please note:** Use the abbreviated colour codes below in the colour section of the order form.

SILVER	BLACK	BRUSHED BRASS
S	B	BRS
BRUSHED NICKEL	BRUSHED BRONZE	GUN METAL
N	BRZ	GUN

**CONFIGURATION** \_\_\_\_\_

(Add configuration number)

GLASS THICKNESS	8mm	10mm	
<b>GLASS SIZE</b>	<b>CODE</b>	<b>QUANTITY</b>	<b>COLOUR</b>
Front Panel Size			
End Panel Size			
Side Panel Size			
<b>WALL PROFILE WITH SEALS</b>	<b>CODE</b>	<b>QUANTITY</b>	<b>COLOUR</b>
Wall Profile 8mm & 10mm	WPS		
<b>BRACING BARS</b>	<b>CODE</b>	<b>QUANTITY</b>	<b>COLOUR</b>
Bracing Bar 1	BB1		
Bracing Bar 2	BB2		
Ceiling Bracket	2CB		
Ceiling to Glass	G2C		
Floor to Glass	F2C		
<b>90° CORNER JOINING OPTIONS</b>	<b>CODE</b>	<b>QUANTITY</b>	<b>COLOUR</b>
Corner Bracket	CNR8		
Corner Seal	CNRSEAL8		N/A
Corner Bracket	CNR10		
Corner Seal	CNRSEAL10		N/A
Corner Post 8mm	CP8		
Corner Post 10mm	CP10		
<b>DEFLECTOR PANELS</b>	<b>CODE</b>	<b>QUANTITY</b>	<b>COLOUR</b>
180° Hinged Deflector Left Hand	PHL		
180° Hinged Deflector Right Hand	PHR		
Deflector Glass and Transparent Seal 8mm	PHG8-030		
Deflector Glass and Transparent Seal 10mm	PHG10-030		
8mm 270° Full Height Hinged Deflector 300mm	BY8		
10mm 270° Full Height Hinged Deflector 300mm	BY10		
Fixed Deflector Panel Inline Bracing Bar	BB3		
Fixed Deflector Glass 8mm	G8-020		N/A
Fixed Deflector Glass 10mm	G10-020		N/A
Optional Foot Kit (for Fixed Deflector)	FTK		



The shower fittings appearing in this brochure are produced by **JTP** a long established tapware brand and , carefully designed in the UK for the UK market.

You will find the colours of **JTP** shower fittings and **Lakes** are complimentary and will help create a wonderful bathroom design scheme.

Visit [www.jtpuk.com](http://www.jtpuk.com) for more details.

# PLAN YOUR OWN PERSONAL SHOWERING SPACE

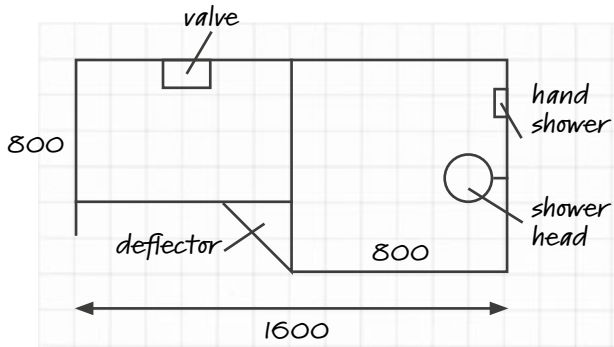

## PRODUCT DETAILS

Images and illustrations printed in this catalogue are for illustrative purposes only. All descriptions within are a guide to explaining each product more clearly. All room layouts, products, finishes and colours are for representation purposes only and it is strongly recommended that you visit an approved Lakes displaying showroom to view the product you are interested in. You can find your nearest dealer by visiting the 'Find a Stockist' section on our website and inputting your postcode.

## INSTALLATION

Full, simple-to-follow instructions are provided with all Lakes' products to ensure a straightforward installation every time. Glass panels are adjustable between the sizes stated. All dimensions are approximate.

All products must be fitted according to our installation instructions. Failure to comply may invalidate the Lifetime Guarantee.

All heights shown for shower doors are taken from the top of the shower tray/tiled floor.

Shower trays/tiled floors must be level, fully plumbed and correctly sealed in accordance with manufacturers' instructions before installing shower glass/enclosures.

Please note that due to the weight of certain products, it may require two people to handle the panels. Please also ensure that the integrity and construction of the wall is suitable to support the weight of the shower panels.

Due to the nature of all wet room shower panel products, water retention within the showering area cannot be guaranteed. Please check with your installer/retailer.

## CARE AND MAINTENANCE

### Daily Care - Glass Panels and Metallic Surfaces:

To prevent the build-up of limescale and water stain marks, don't allow water droplets to dry on the glass or frames. After showering, rinse the glass with water, remove residual water using a squeegee and wipe the frame with a soft cloth.

### Regular, Deep Cleaning - Glass Panels and Metallic Surfaces:

All Lakes' glass panels have been treated with AllClear® - a hydrophobic coating which aids the run-off of water droplets and reduces the need for frequent cleaning.

To ensure that your glass panels stay looking good as new, regular weekly/ fortnightly cleaning is recommended depending on your local water (hardness) conditions. Use only mild soap or detergent solutions to clean. Rinse with water, then squeegee the glass panels and wipe the frames dry with a soft cloth. Under no circumstances should abrasive, caustic, acidic or scouring products be used.

Cleaning products should have pH value 4 ~ 8. Do not use 'proprietary "spray & leave" type cleaning products. Non-compliance with these cleaning instructions may cause colour finishes to deteriorate and could adversely affect the safe operation of the enclosure.

### Removing Limescale - Glass Panels and Metallic Surfaces:

To prevent limescale build-up or to remove limescale, use a 50:50 solution of white vinegar and water. Apply with a soft cloth, leave to soak for 30 minutes (longer for areas with severe limescale accumulation) and rinse/dry thoroughly afterwards. Impairment caused to the product's finish and caused by limescale build up will invalidate product guarantees.

## ERRORS AND OMISSIONS.

In the interests of continuous design, development and product improvement, Lakes Showering Spaces reserves the right to amend designs, product specifications, colours and pricing without prior notice.





**LAKES**  
SHOWERING SPACES

**LAKES**

Alexandra Way  
Ashchurch  
Tewkesbury  
Gloucestershire  
GL20 8NB

T: 01684 853870

F: 01684 857411

[info@lakesshoweringspaces.com](mailto:info@lakesshoweringspaces.com)

[lakesshoweringspaces.com](http://lakesshoweringspaces.com)

